

- Coach Areas
- Sleeper Bedrooms**
- Food & Beverage
- Toilets & Showers
- Common Use Areas

Sleeper Bedrooms

- Coach Areas
- Sleeper Bedrooms**
- Food & Beverage
- Toilets & Showers
- Common Use Areas

Amtrak® Long Distance Product Features

04 | Roomette

Roomette | Features

Roomette | Features

Seat Headrests
Seat headrest should be adjustable in height for a range of people sizes and have adjustable wings that fold outwards to adjust the width of the headrest.

Seat Comfort
Seat cushions should be contoured to aid seat comfort.

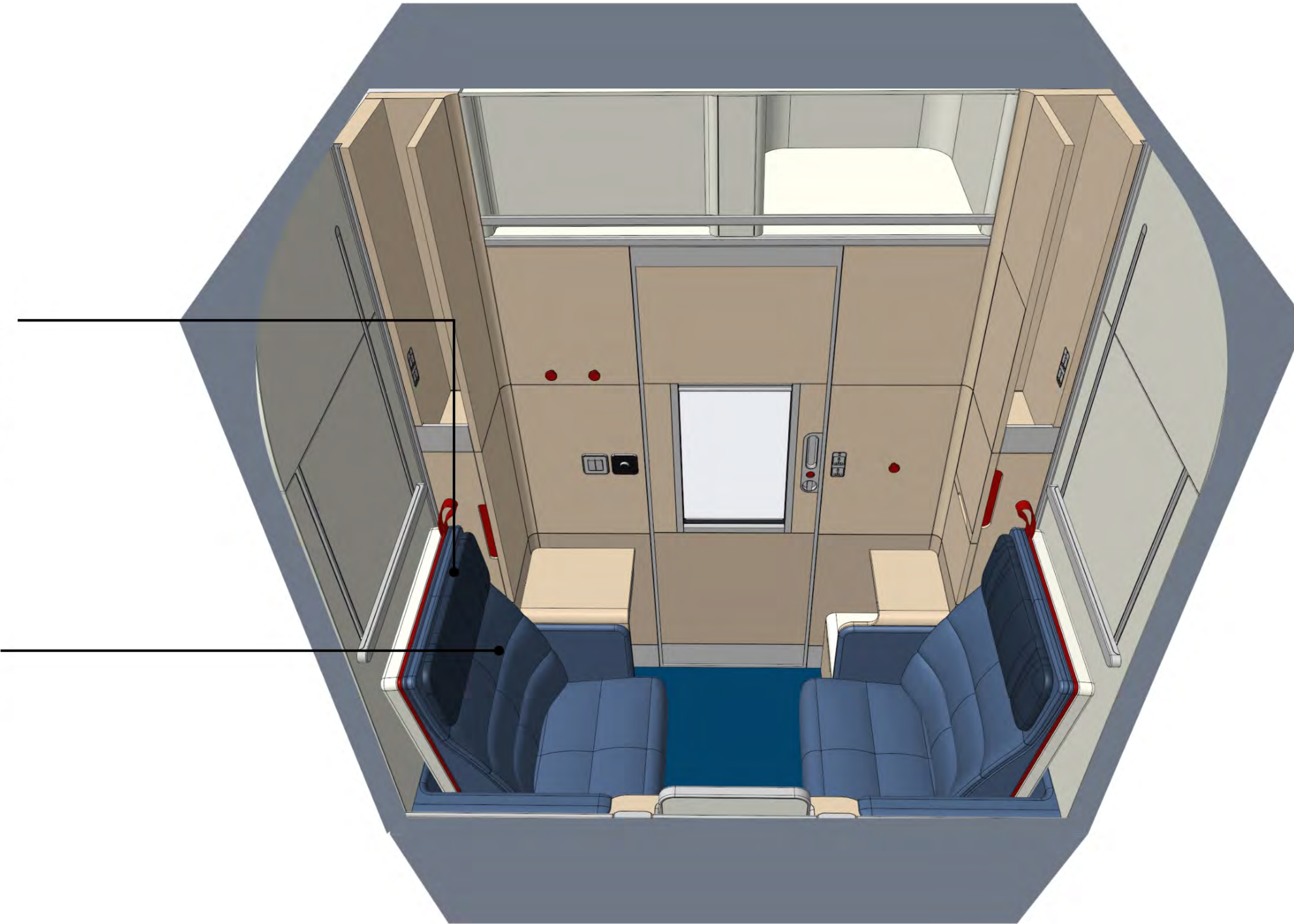

Roomette | Features

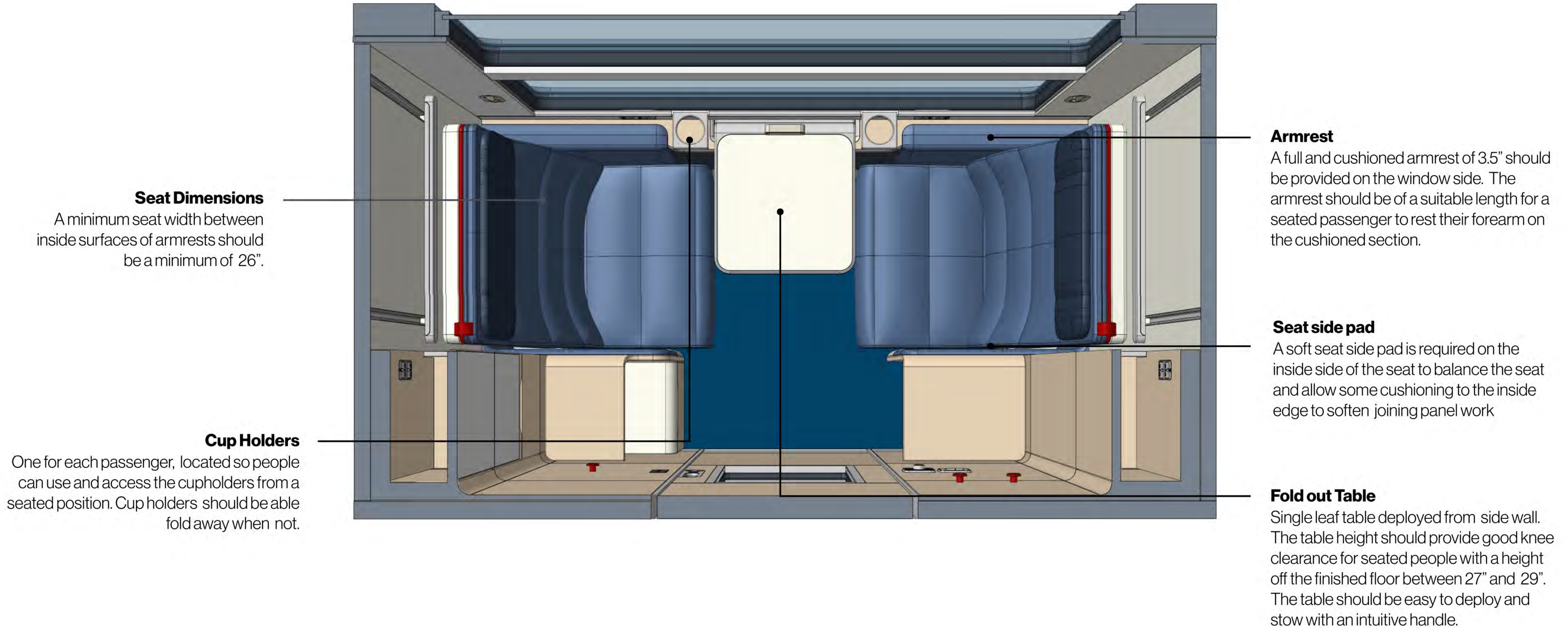

Seat Dimensions

A minimum seat width between inside surfaces of armrests should be a minimum of 26".

Cup Holders

One for each passenger, located so people can use and access the cupholders from a seated position. Cup holders should be able to fold away when not.

Armrest

A full and cushioned armrest of 3.5" should be provided on the window side. The armrest should be of a suitable length for a seated passenger to rest their forearm on the cushioned section.

Seat side pad

A soft seat side pad is required on the inside side of the seat to balance the seat and allow some cushioning to the inside edge to soften joining panel work

Fold out Table

Single leaf table deployed from side wall. The table height should provide good knee clearance for seated people with a height off the finished floor between 27" and 29". The table should be easy to deploy and stow with an intuitive handle.

Roomette | Features

Seat Dimensions

All seat dimensions, cushion density/ shore hardness will be subject to mockup review and approval by Amtrak

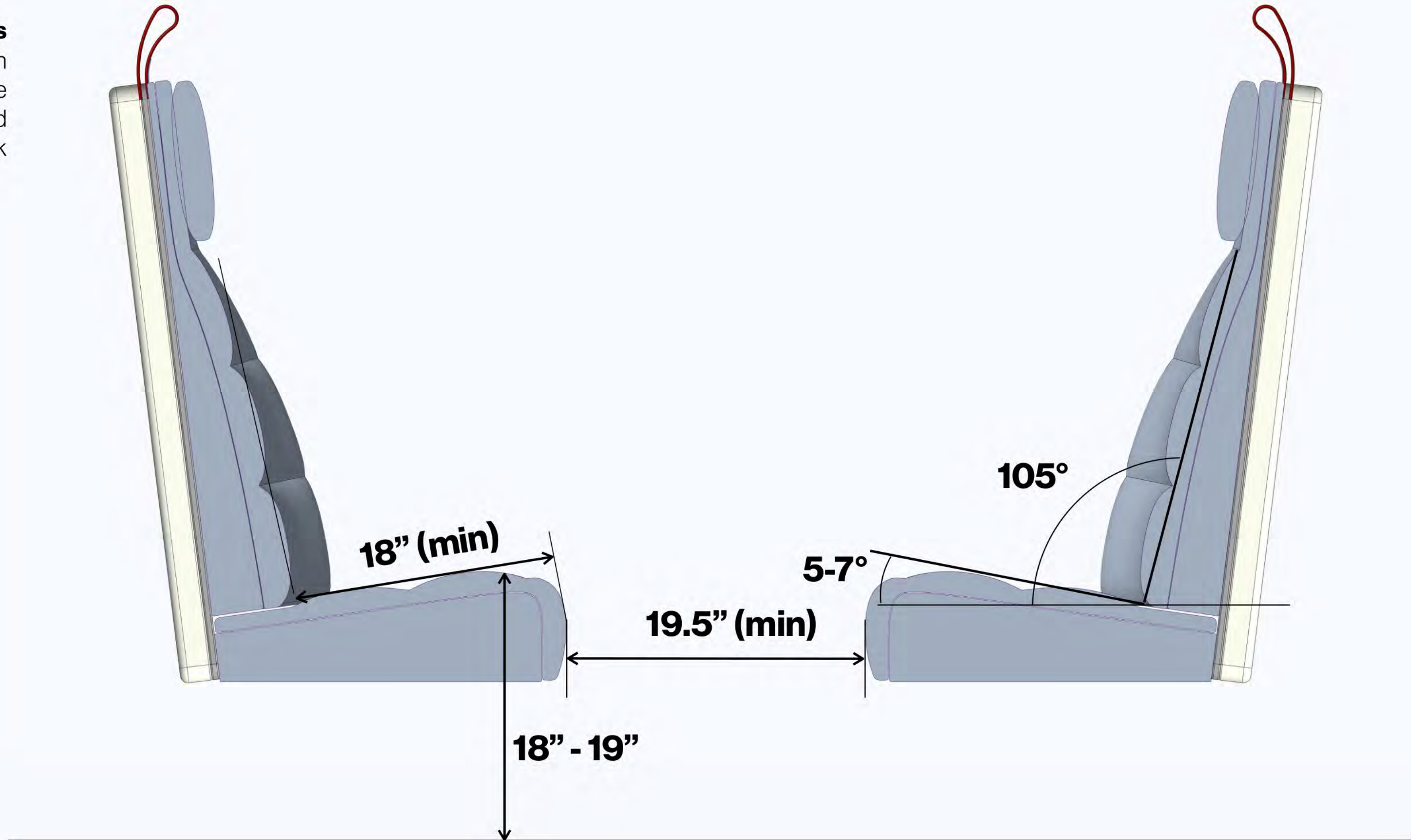

Roomette | Features

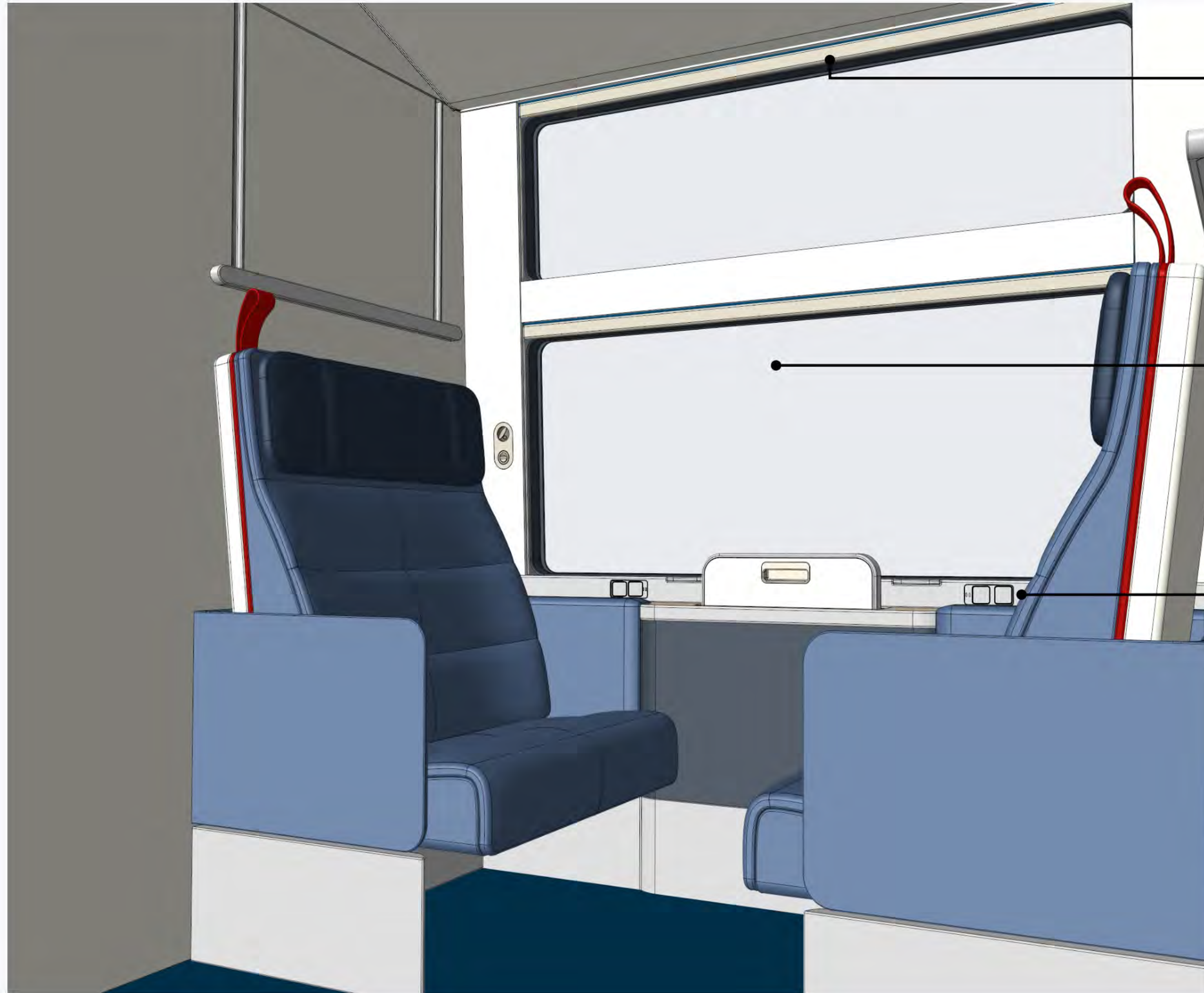

Blinds

A single pull-down blind system shall be provided per window, capable of delivering both daytime solar/glare control and full blackout performance.

Window and Window Mask

Window and window mask should be central to the room and overall window size maximized.

At Seat Power

Two power sockets and two USB sockets should be provided to each seated location. The position should be above the armrest height and in easy reach of people while seated.

Roomette | Features



Door Window and Blind
 Door window should be central to door and come equipped with an integrated blinds

Power Outlets
 Two power sockets and two USB sockets positioned on outer wall in close proximity to vanity area

Door Handle and Lock
 Door handles should be positioned to slide door easily open and closed. An accessible manual lock should be included with an indicator to show lock condition.

Door
 Door free from rattle, smooth sliding operation.

Master Light Switch
 Master Light switches to be positioned near door. A second master switch should be safely accessible by a person lying in the top bunk

Temperature Control

Roomette | Features

Handrails and Grabs
 Suitable handholds shall be provided to assist people transiting to the bunk when deployed..

Minimum clear way
 A free clear channel of at least 14" should be provided. Key dimensions and access to the upper bunk will be subject to mockup testing and Amtrak approval.

HVAC
 HVAC control in the room should have a feature that allows passengers to adjust the direction of airflow away from their sleeping positions.

Mirror
 The mirror on the front of the vanity unit should be suitable for people to see their reflection while standing.

Fold Out Sink

Steps
 At least two integrated steps should be built into the area beside the seat to allow people to safely transit to the upper bunk. Step surfaces shall be free from trip hazards and have an anti-slip finish to the tread surfaces. Steps shall be designed in such a way that the seat cushions, armrests or any soft furnishings are protected and clear of tread surfaces.

Trash Bin

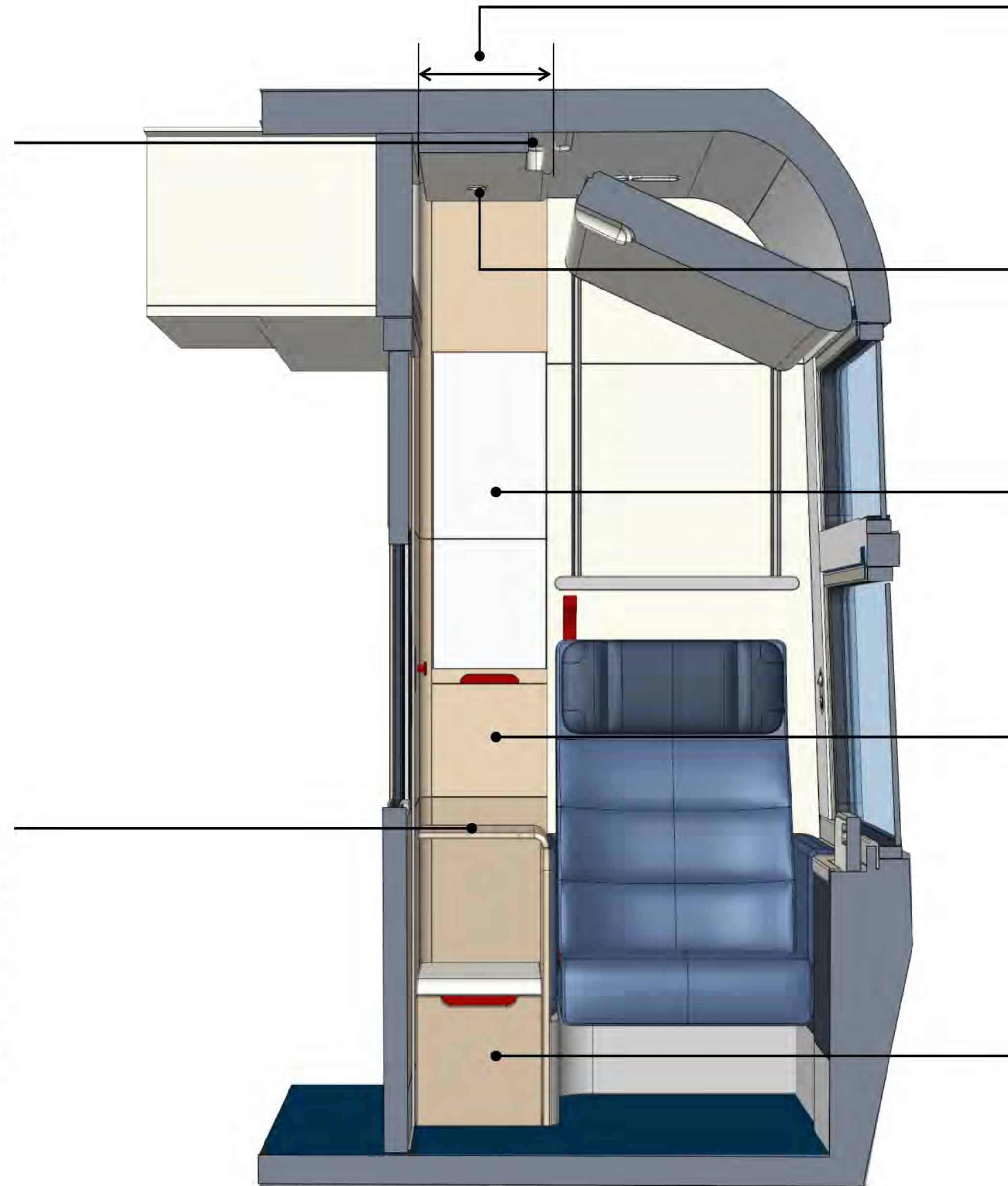

Roomette | Storage

Roomette | Storage

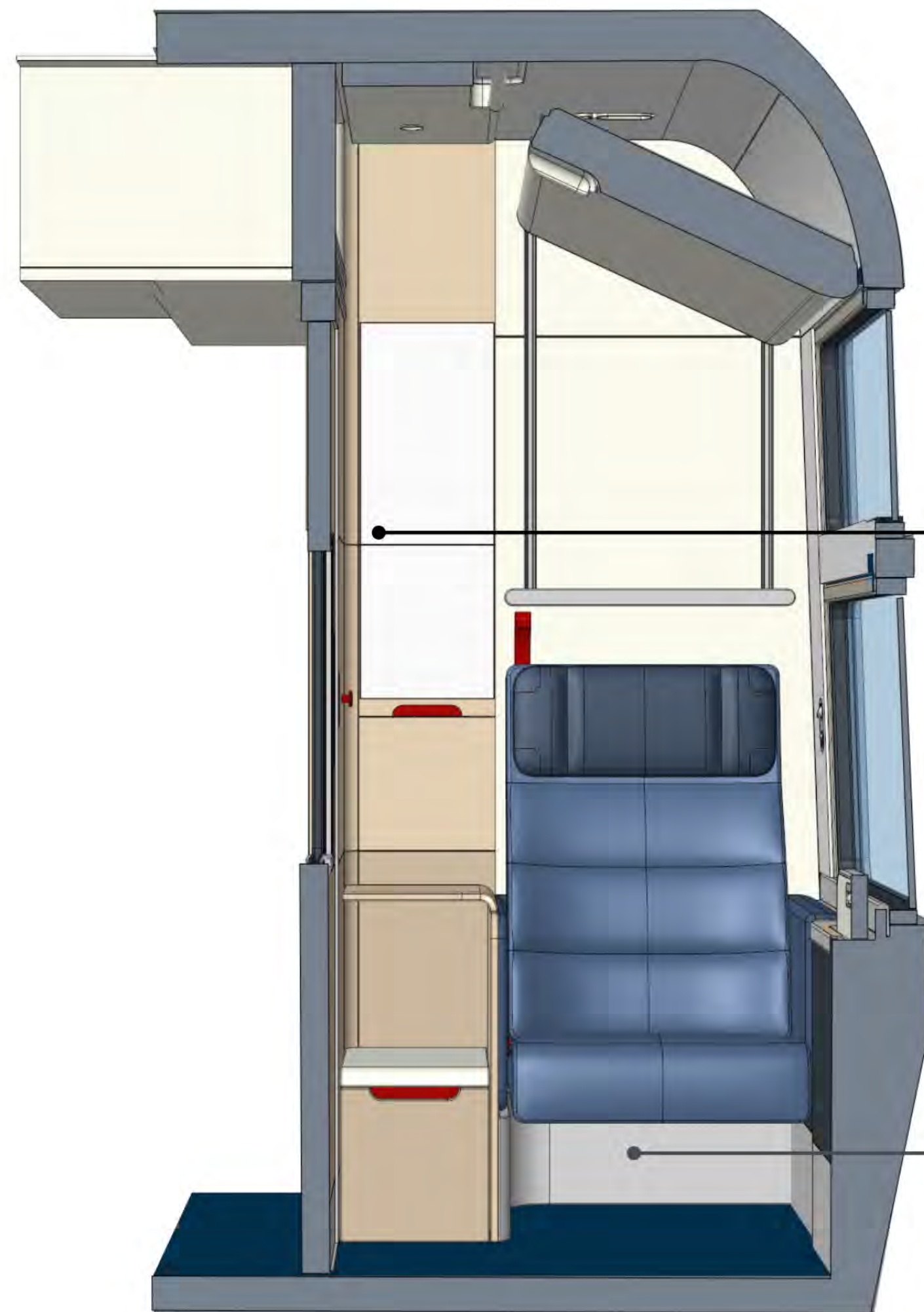

LH Side

Cabinet
Shelved cabinet with retaining bars for clothes and personal items.

Vanity Cabinet
Shelved cabinet for toiletries, hand towels and face cloths (2 of each Amtrak's standard towels supplied). Space required for integrated tissue dispenser.

Carry On Stowage Area
Maximize area beside seat for small carry on luggage. Area should be protected from seat area so luggage can be stored discreetly out of the way.

Under Seat Stowage
Space under the both seats should remain free for carry on luggage. No seat mechanism or structure should preclude the ability to store large carry on bags.

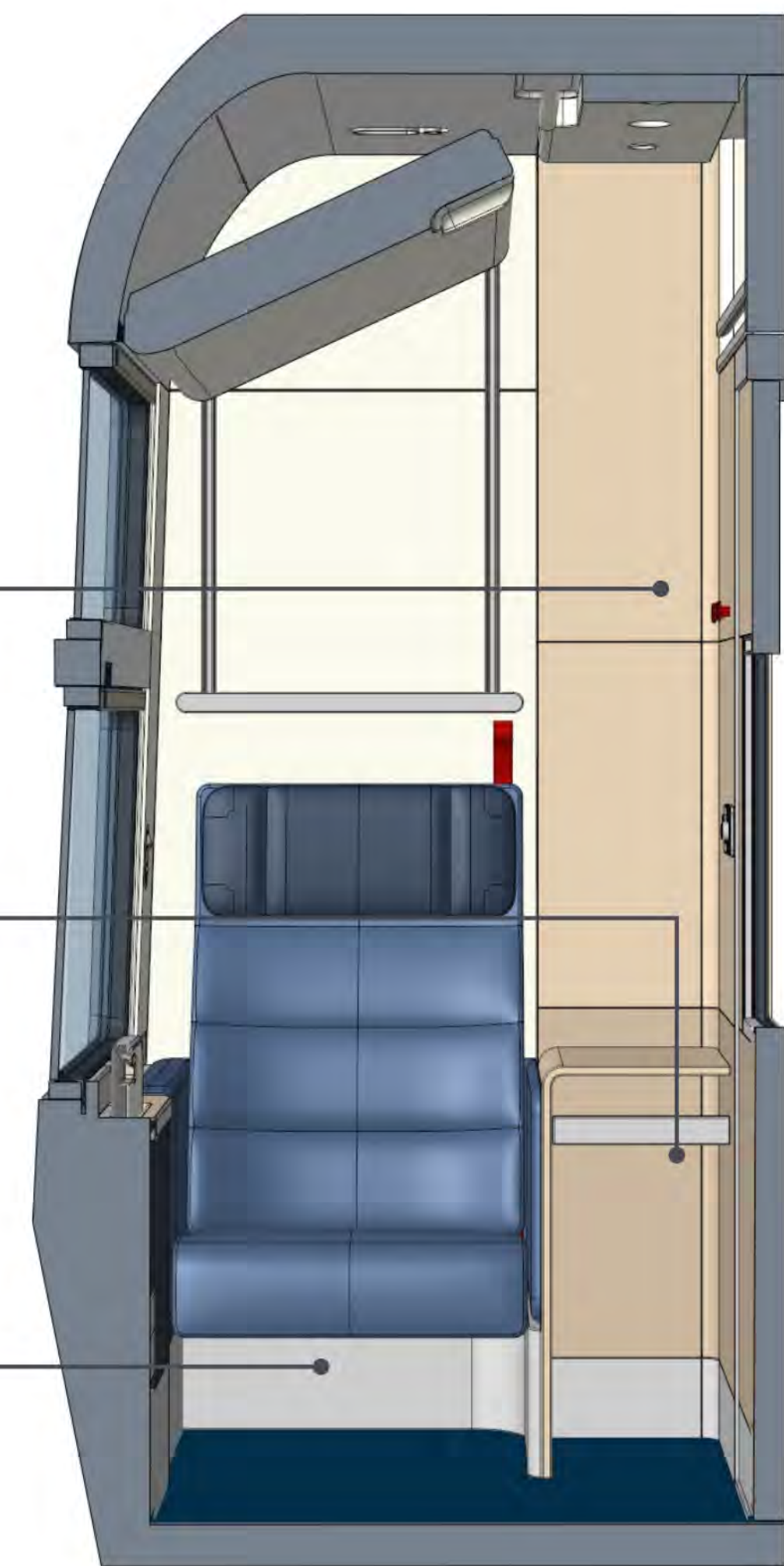

RH Side

Roomette | Storage

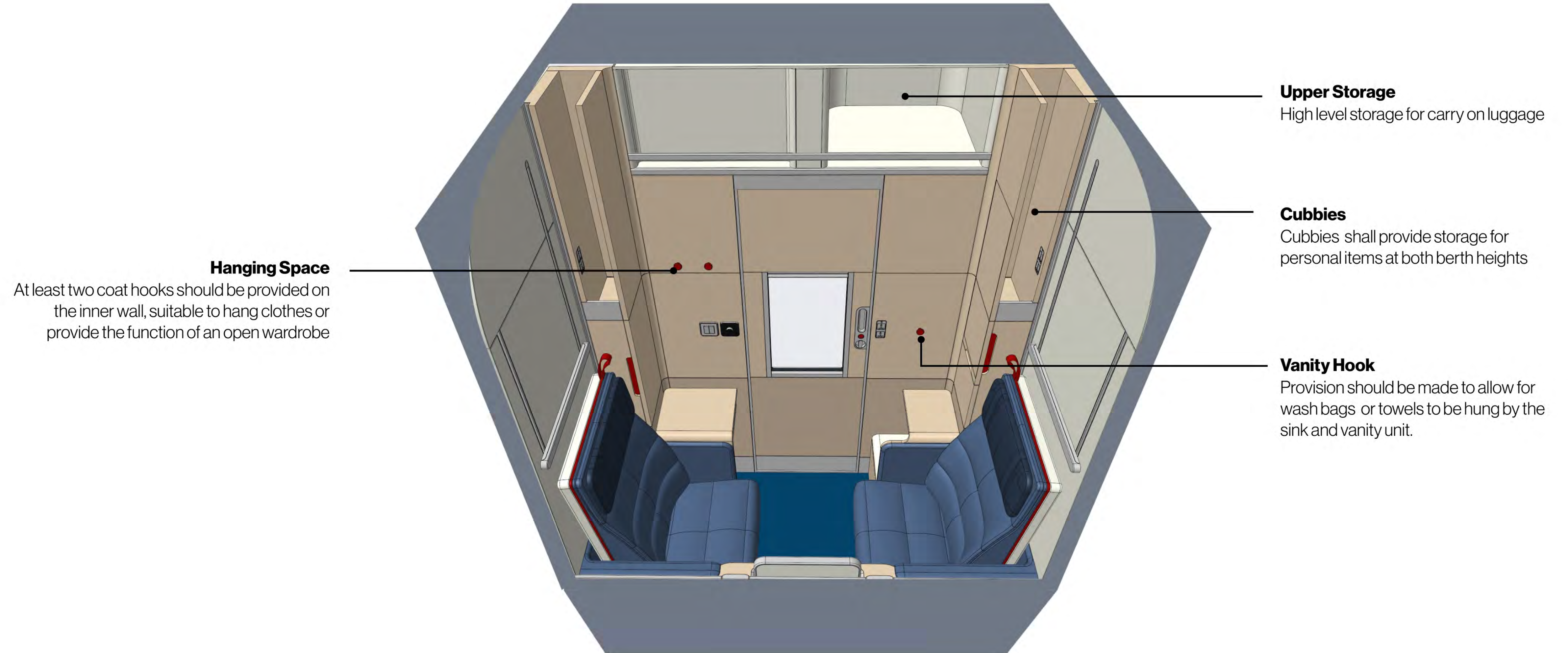

Roomette | Seat to Bed Conversions

Roomette | Seat to Bed Conversions



Lower Berth Deployment

A simple unlatch mechanism is required to convert the seats into a lower bed/berth. This should be positioned in a place that is easy for people to use and designed in a way so that people can understand its purpose.

Upper Bunk

Bunk should be stored horizontally at an optimized height in the room. Bunk should not preclude any part of the window when stowed.

Upper Bunk Deployment

A simple and easy to use handle, latch and lock mechanism should be within easy reach from a standing position. Successful locking should be visually indicated and safety measures should be put in place to prevent accidental deployment and prevent misuse.

Roomette | Seat to Bed Conversions

Bunk Retaining Straps

Retaining straps are required to prevent people from rolling out of the bunk. These should retract into the ceiling and be easily pulled down and click into place using an automatic locking retractor belt system (similar to a car seat belt system).

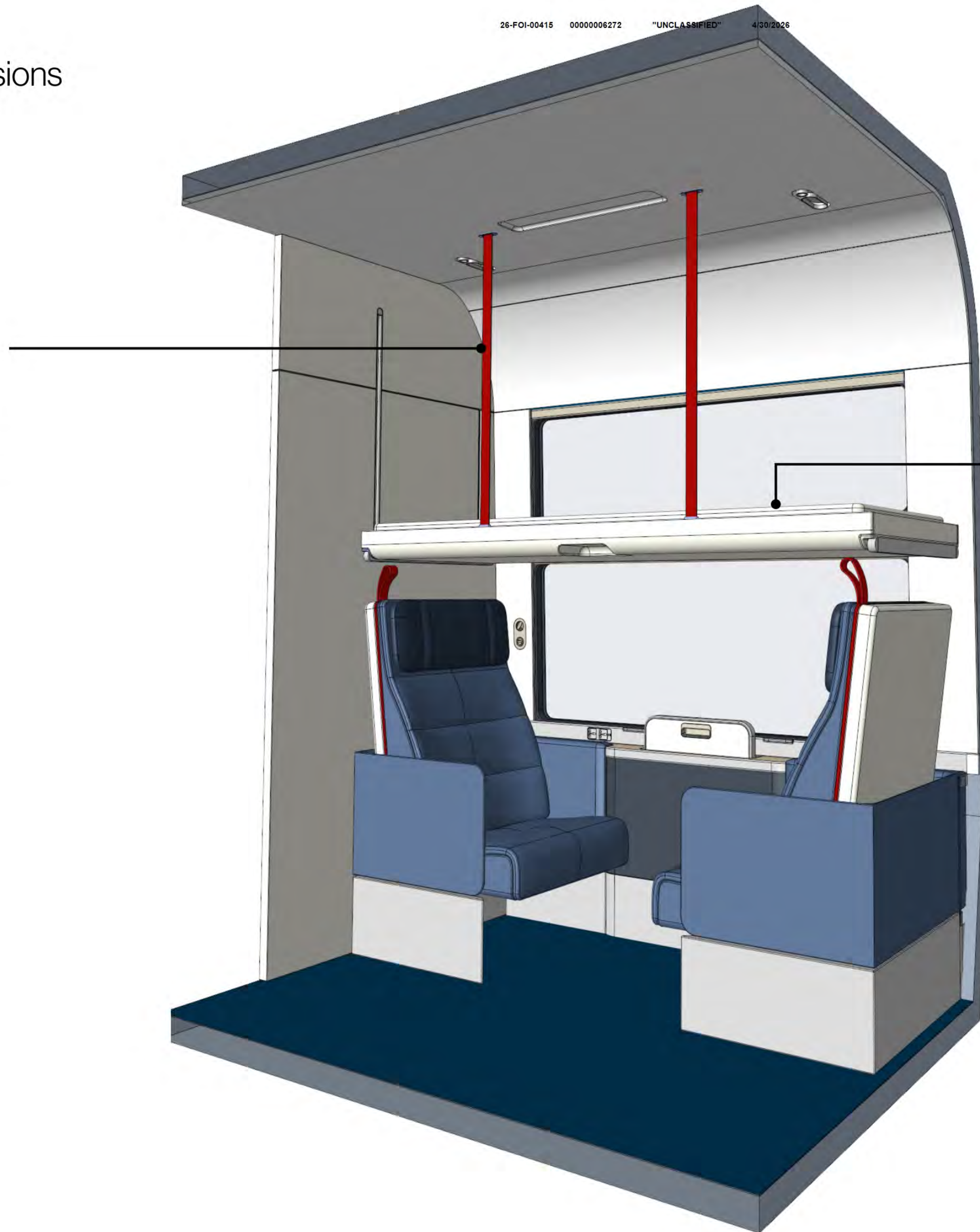

Bunk Height

The seated area below the bunk should still be usable by seated passengers when the upper bunk is deployed.

Roomette | Seat to Bed Conversions

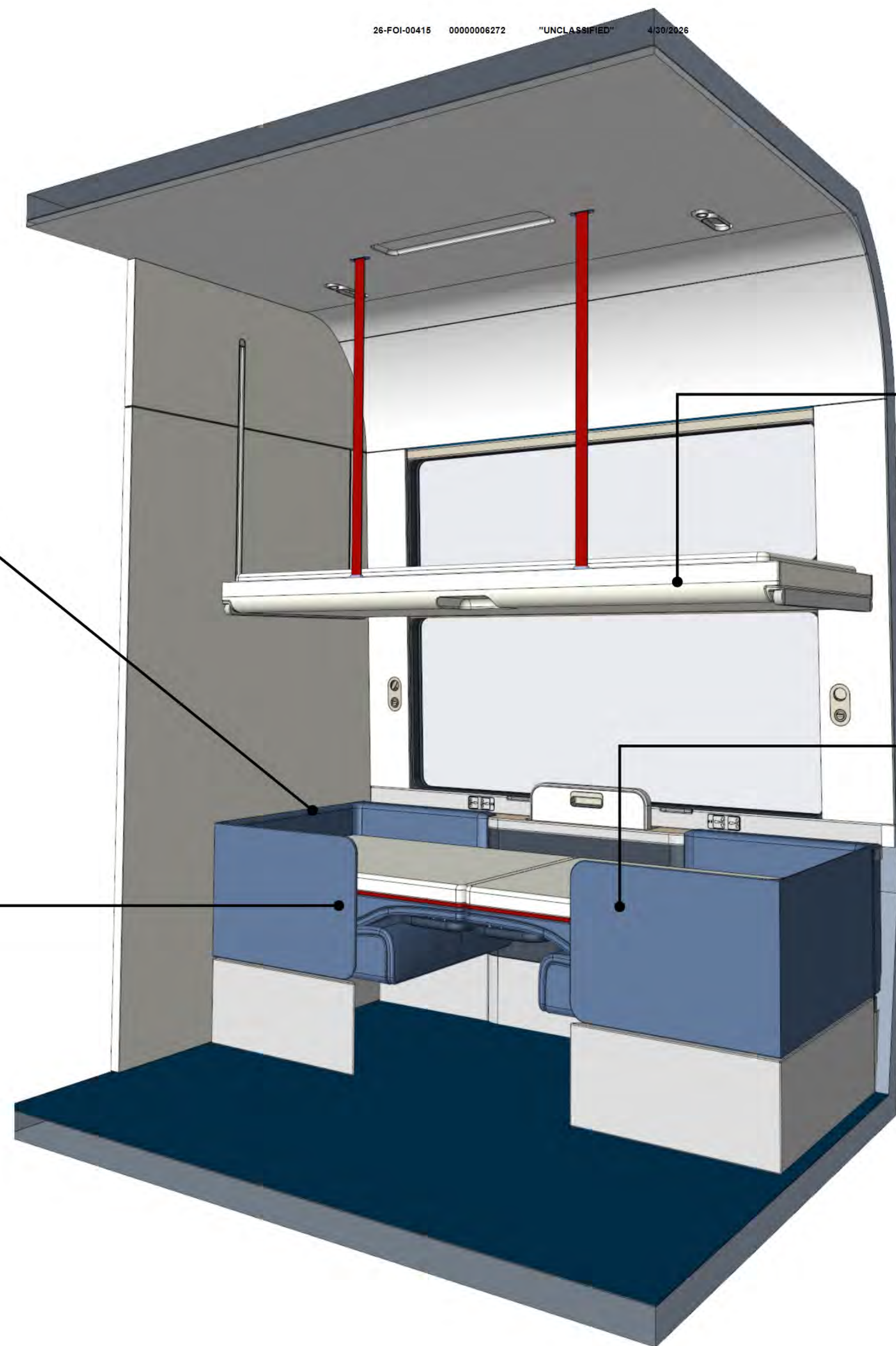

Head Board

The armrest and seat side pad should continue and connect to form a thin soft headboard around the back of the seat when the bed for the lower berth is down.

Lower Berth

Conversion of seats to bed should result in an entirely flat bed surface. The mattress surface should be integral to the seat. A single seam between the bed surface is acceptable with a single thin topper to finish the bed surface.

Bunk Dimensions

Minimum width 27" x Minimum length 77"

Lower Berth Dimensions

Minimum width 27" x Minimum length 77"

Roomette | Lighting

Roomette | Lighting

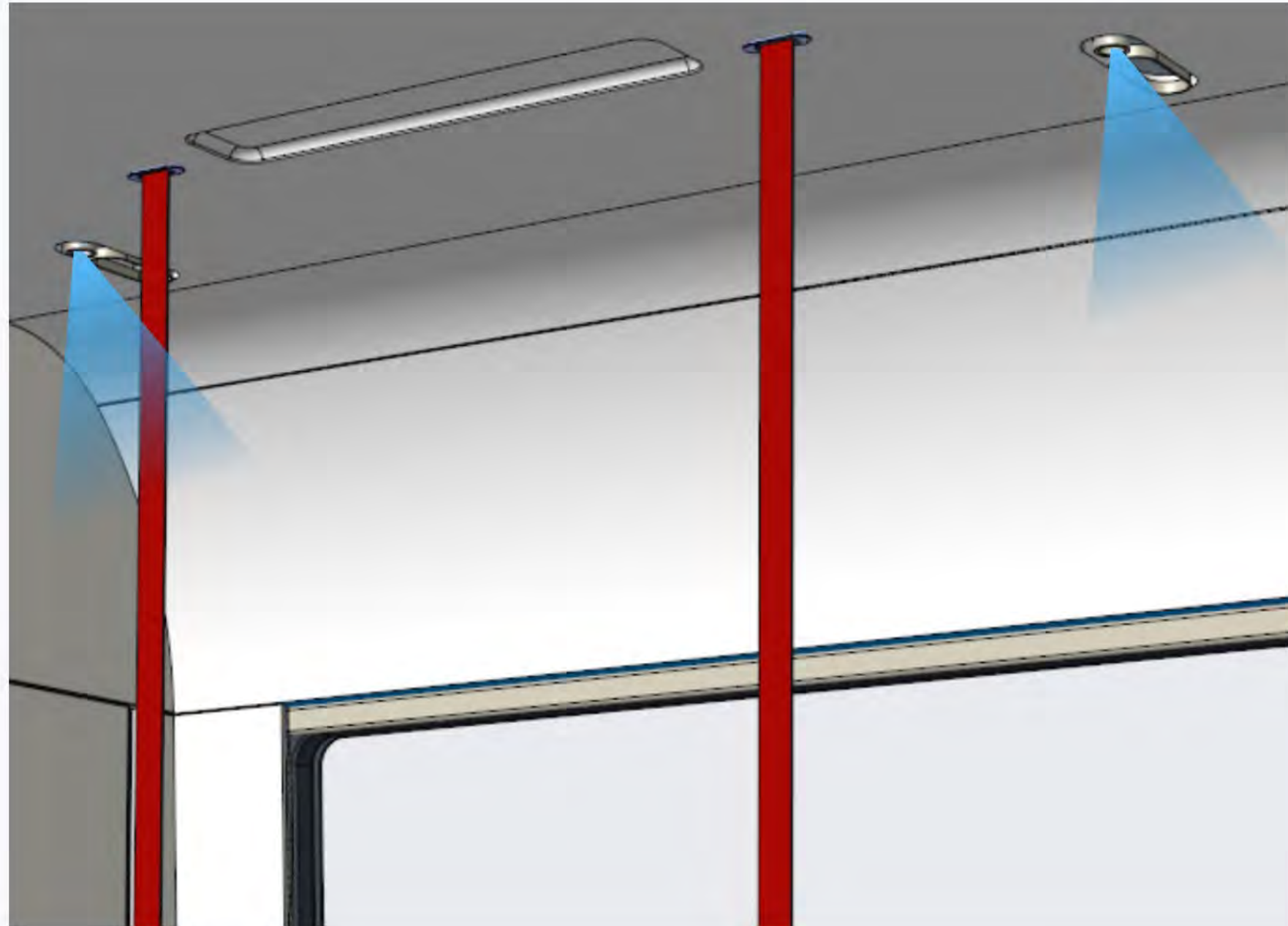

Upper Reading Lights

Reading lights should be provided embedded in ceiling above the bunk. These should be mini panel lights. 2 lights in total located at each end of the bed. Light switches should be located next to the reading light.

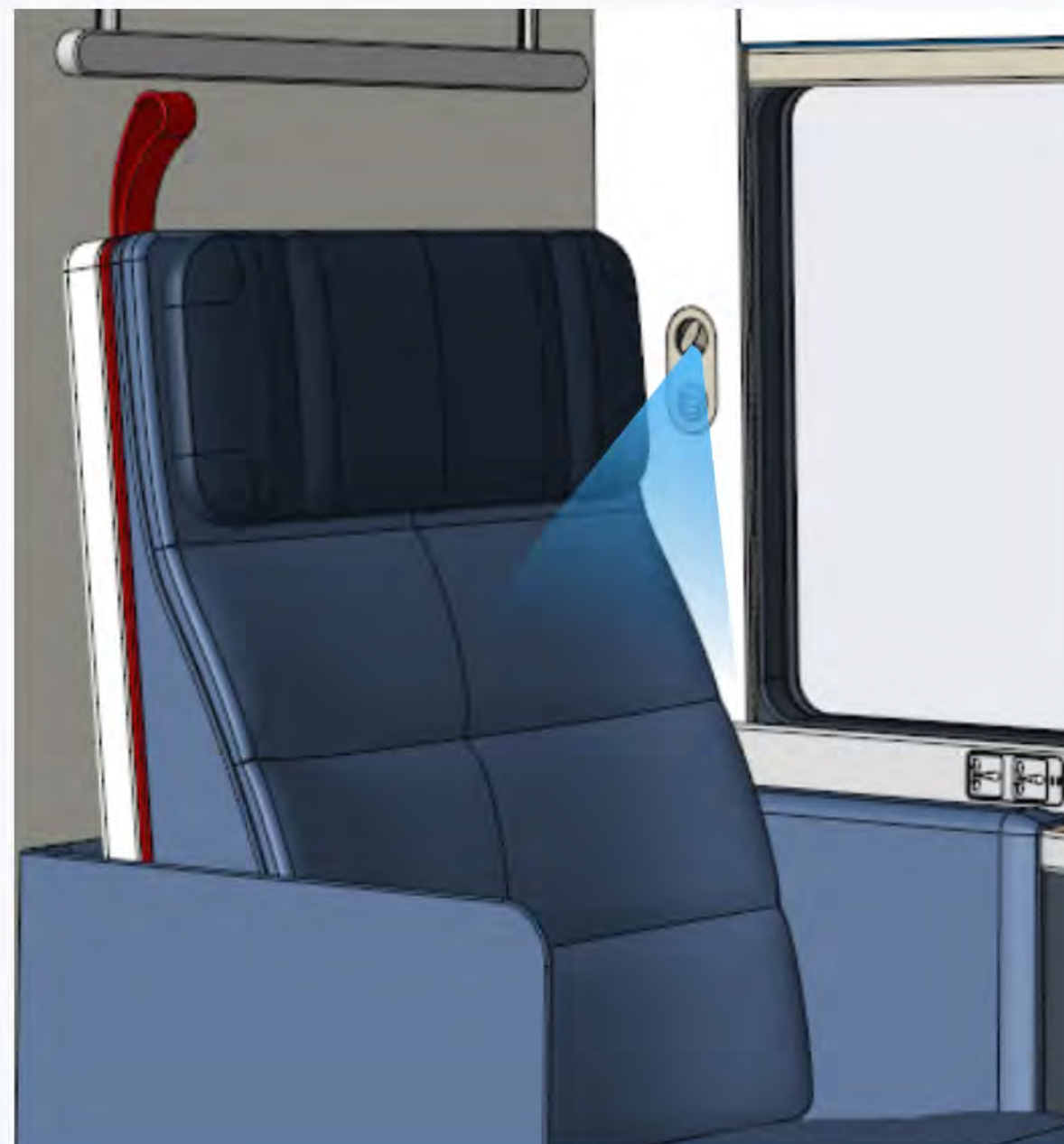

Lower Reading Lights

Reading lights should be provided at each seated location. People should be able to adjust the direction position of the light over their lap and in a suitable way to read a book at night. Switches should be located near or on the light.

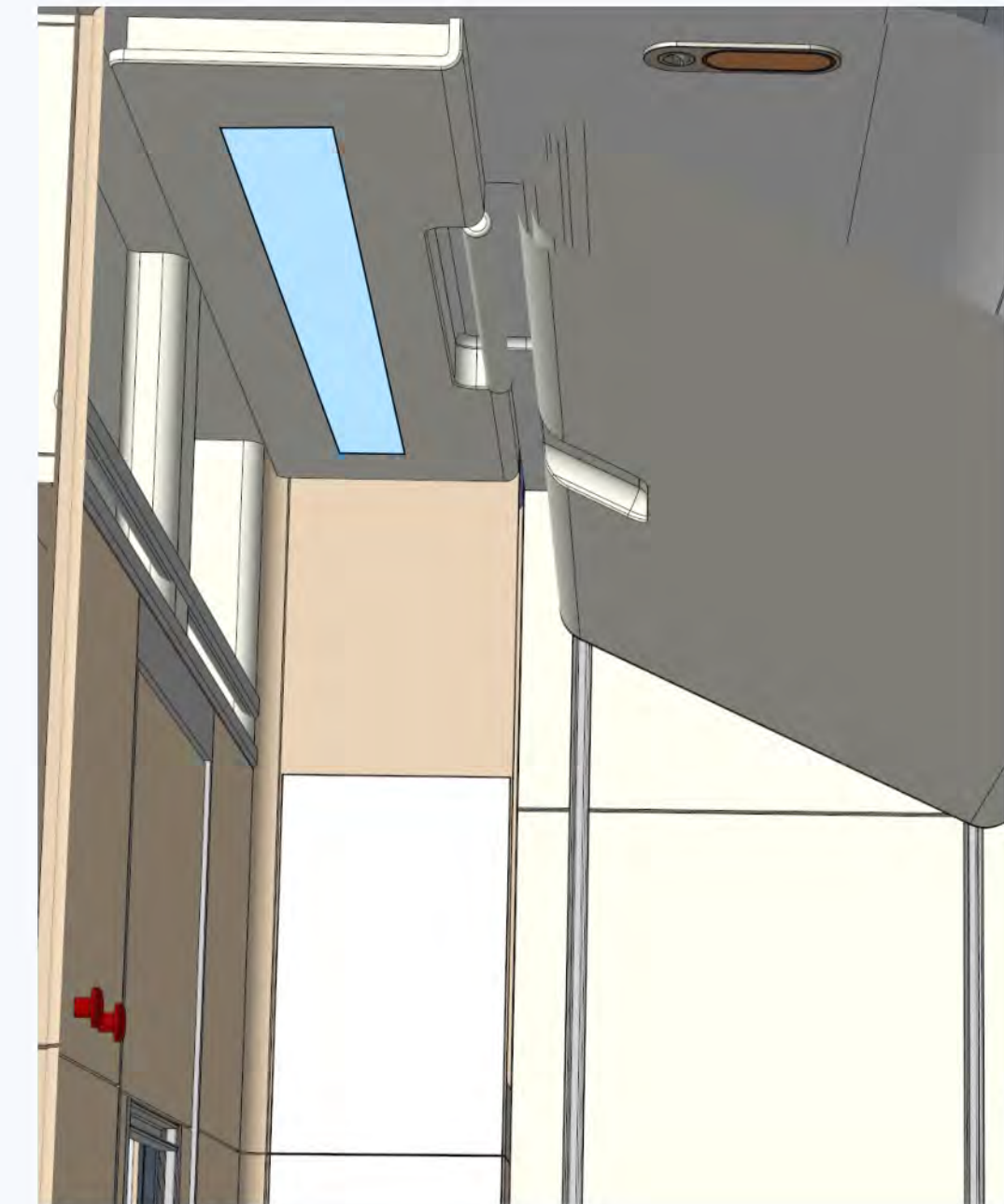

LED light panel light

LED light panels or panel spot lights provide ceiling master lights.

*See lighting spec for detailed definition

Roomette | Lighting

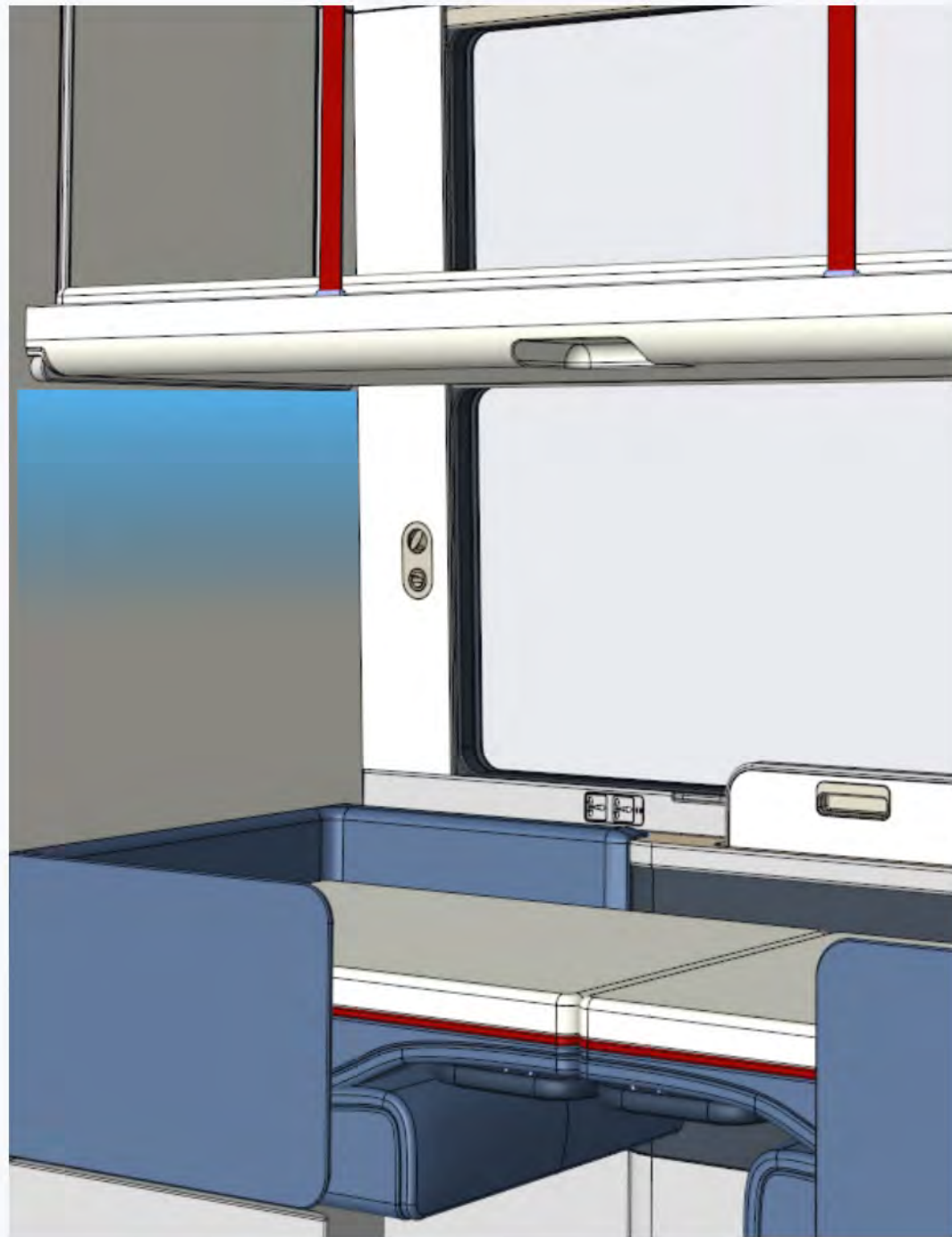

Back Wall Wash Light

Bunk support runner washes indirect light down the end walls on both sides of the room.



Back Wall Wash Light

Bunk support runner washes indirect light up across the end walls on both sides of the room.



Under Seat Light

Under seat light should be indirect and spill light out across the floor.



Step Light

Indirect light provides wash light over the steps.

*See lighting spec for detailed definition

- Coach Areas
- Sleeper Bedrooms**
- Food & Beverage
- Toilets & Showers
- Common Use Areas

Amtrak® Long Distance Product Features

05 | SoloSuite

Solo Suite | General

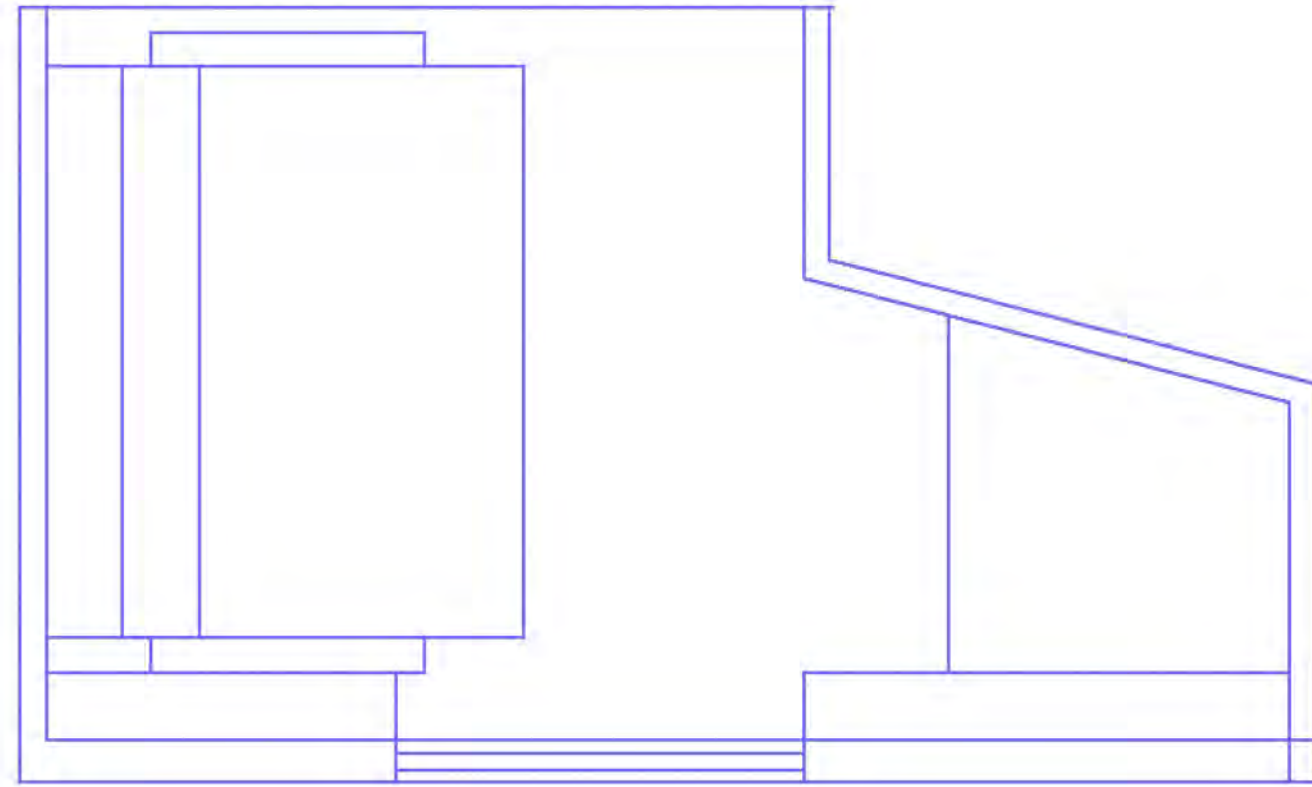

Solo SoloSuite

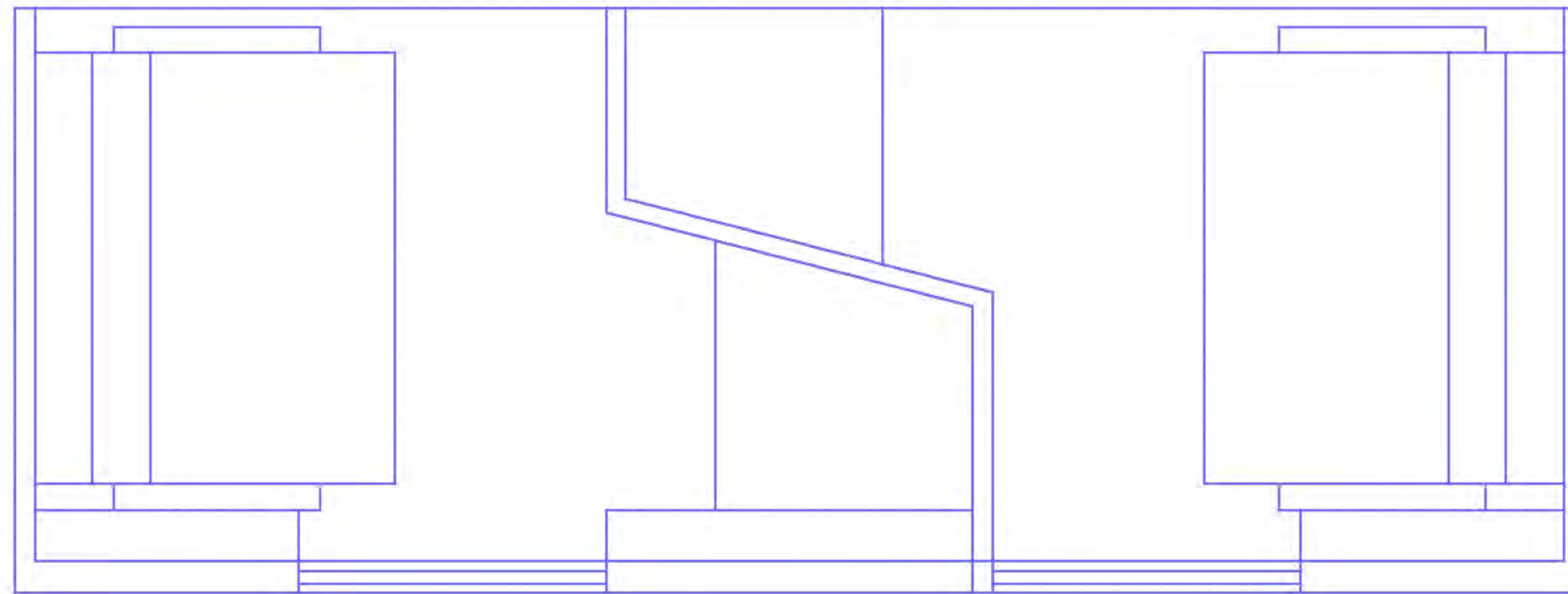

Twin SoloSuite

SoloSuite

SoloSuite is a room designed and optimized for a single occupant. SoloSuite rooms can be combined with a mirrored version of the room to create a larger twin room for two.

***The following diagrams illustrate two SoloSuite rooms as a facing pair.**

SoloSuite

SoloSuite rooms should be optimized for a central 24" aisle. Two SoloSuite modules combined (or facing pair) should be designed to a minimum length of 122".

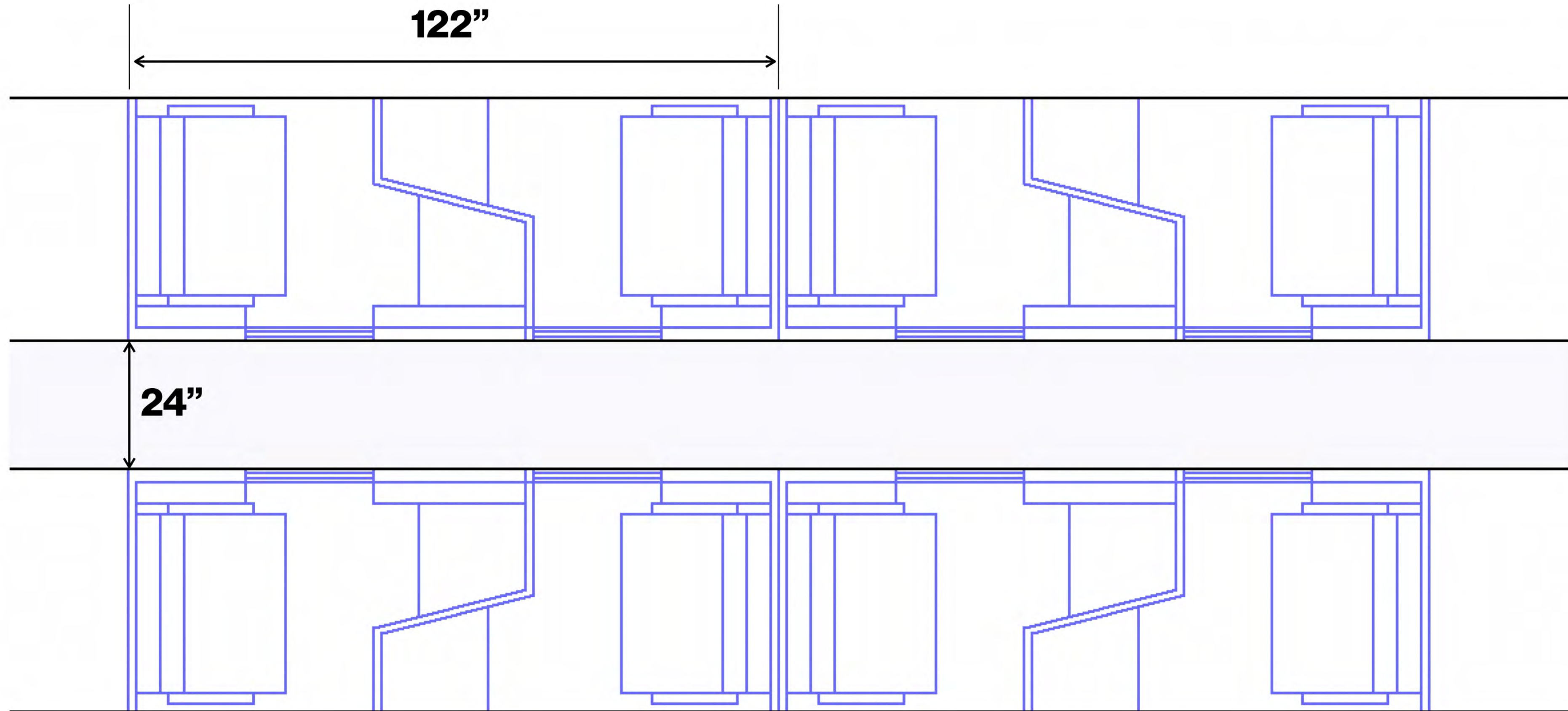

Solo Suite | Features

Solo Suite | Features

Seat Headrests
Seat headrest should be adjustable in height for a range of people sizes and have adjustable wings that fold outwards to adjust the width of the headrest.

Seat Comfort
Seat cushions should be contoured to aid seat comfort.



Seat Fold Out Sink
Fold out sinks shall be provided inside vanity cabinets

Trash
Trash bins shall be provided in each room located under central console.

Solo Suite | Features

Seat Tracking

Seat should track forward so customers can utilize the large central table. The result will provide some recline for the seat.

Seat Dimensions

A minimum seat width between inside surfaces of armrests should be a minimum of 34". It should be possible to invite a companion into the room and comfortably sit side by side on the same seat.

Ottoman

A fixed ottoman should be provided inside a foot-box. A foldable portion of the ottoman should fold up to complete the bed surface and down to provide some standing space when the main part of the bed is deployed.

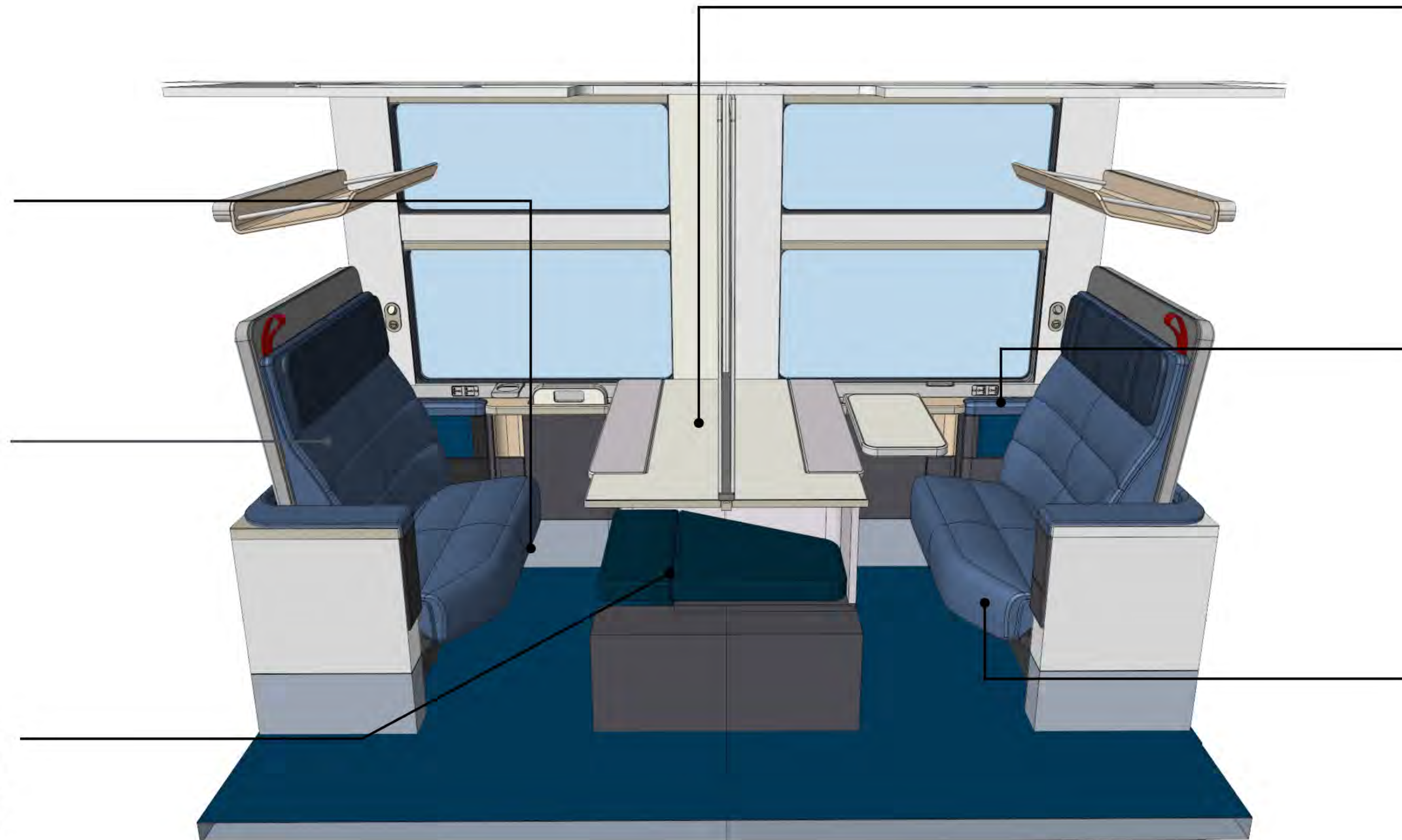

Central Console

A fixed central console houses foot-boxes for the facing SoloSuite pairs. Careful balance between each pair should be considered to maximize living accommodation for each of the passengers.

Armrest

A full and cushioned armrest of 3.5" should be provided on both sides of the seat. The armrest should be of a suitable length for a seated passenger to rest their forearm on the cushioned section.

Seat pan shape

The seat pan should be profiled to maintain ingress and egress clearance. This is a high wearing area of the seat surfaces and this area should be suitably designed to be durable and free from snagging or entrapment.

Solo Suite | Features

Cup Holders

Each room should have one cup holder located so people can use and access the cupholders from a seated position. They should fold away when not in use.

Window and Window Mask

Window and window mask should be central to the room and overall window size maximized.

At Seat Power

Two power sockets and two USB sockets should be provided to each seated location. The position should be above the armrest height and in easy reach of people while seated.

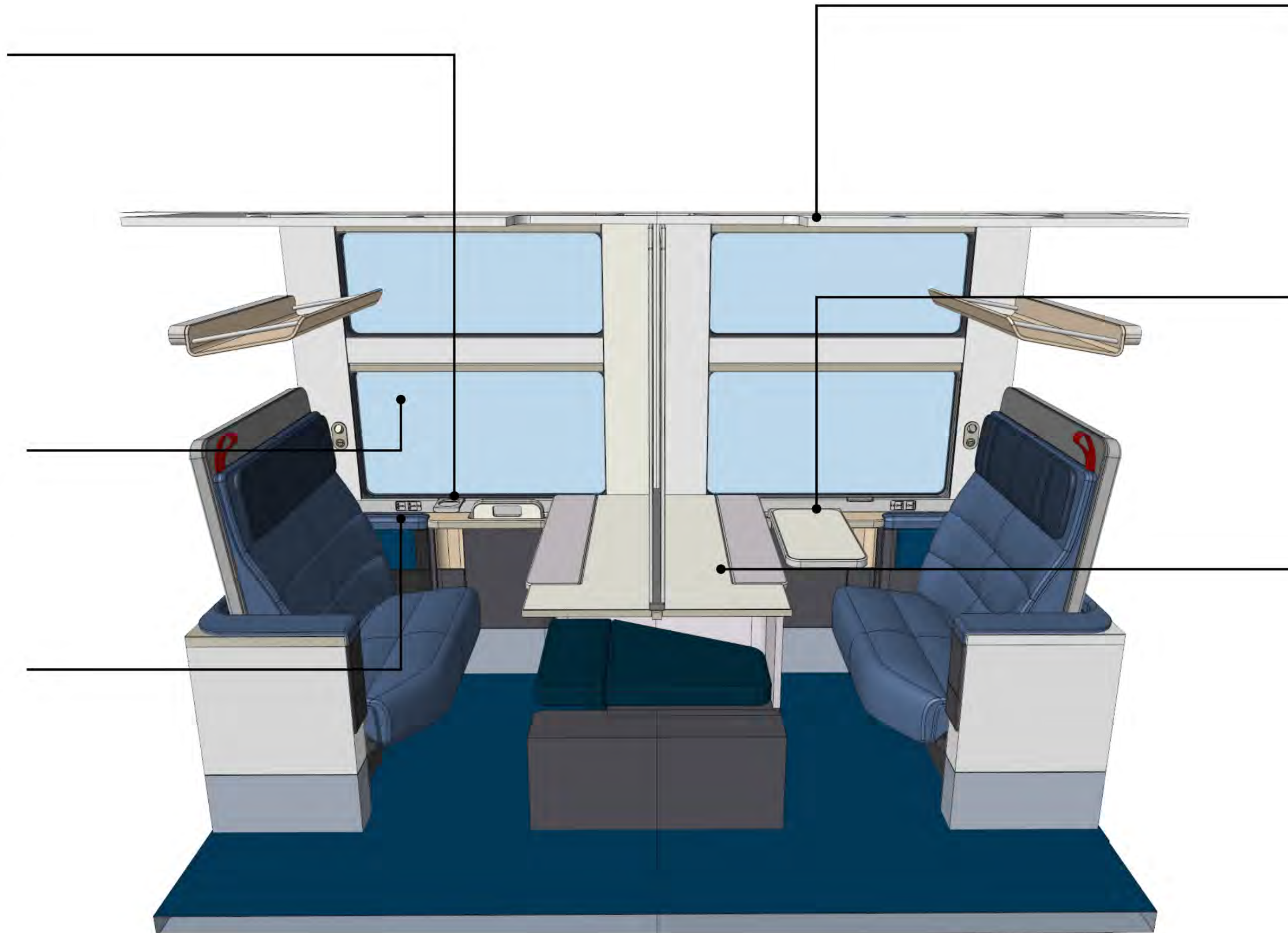

Blinds

A single pull-down blind system shall be provided per window, capable of delivering both daytime solar/glare control and full blackout performance.

Fold out Table

Single leaf table deployed from side wall. The table height should provide good knee clearance for seated people with a height off the finished floor between 27" and 29". The table should be easy to deploy and stow with an intuitive handle.

Ottoman Table

The ottoman table should be large enough for face to face dining. When the seat is tracked forward. It should incorporate a folding leaf to create extra knee and turnover space for sleeping passengers. The leaf must not interfere with divider mechanism when folded.

Solo Suite | Features



Door

Door free from rattle, smooth sliding operation.

Master Light Switch

Master light switches to be positioned near door. A second master switch should be safely accessible by a person lying in the top bunk.

Temperature Control

Door Window and Blind

Door window should be central to door and come equipped with an integrated blind.

Door Handle and Lock

Door handles should be positioned to slide door easily open and closed. An accessible manual lock should be included with an indicator to show lock condition.

Solo Suite | Features

Seat Dimensions

All seat dimensions, cushion density/ shore hardness will be subject to mockup review and approval by Amtrak

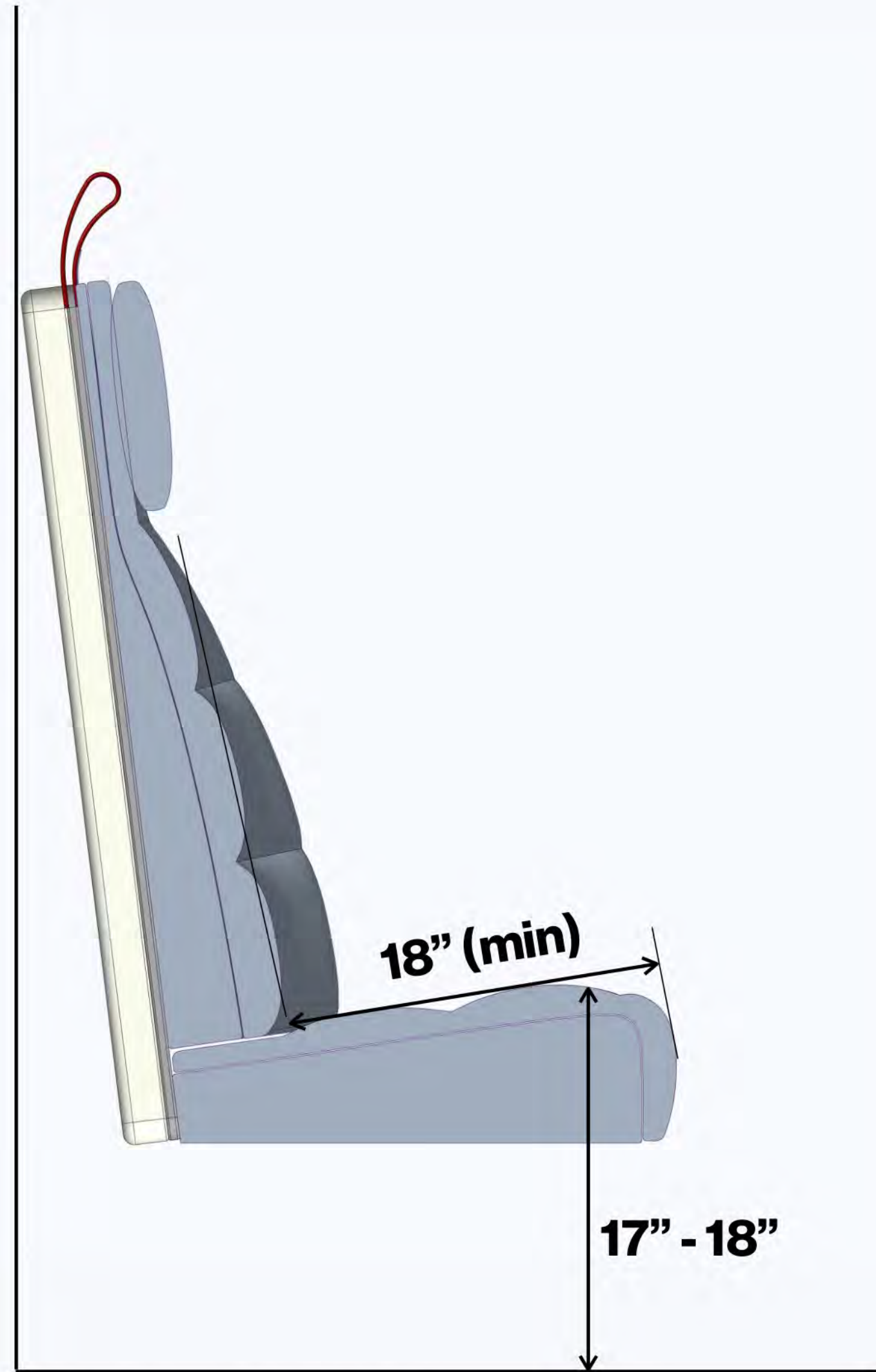

DRAWINGS NOT TO SCALE

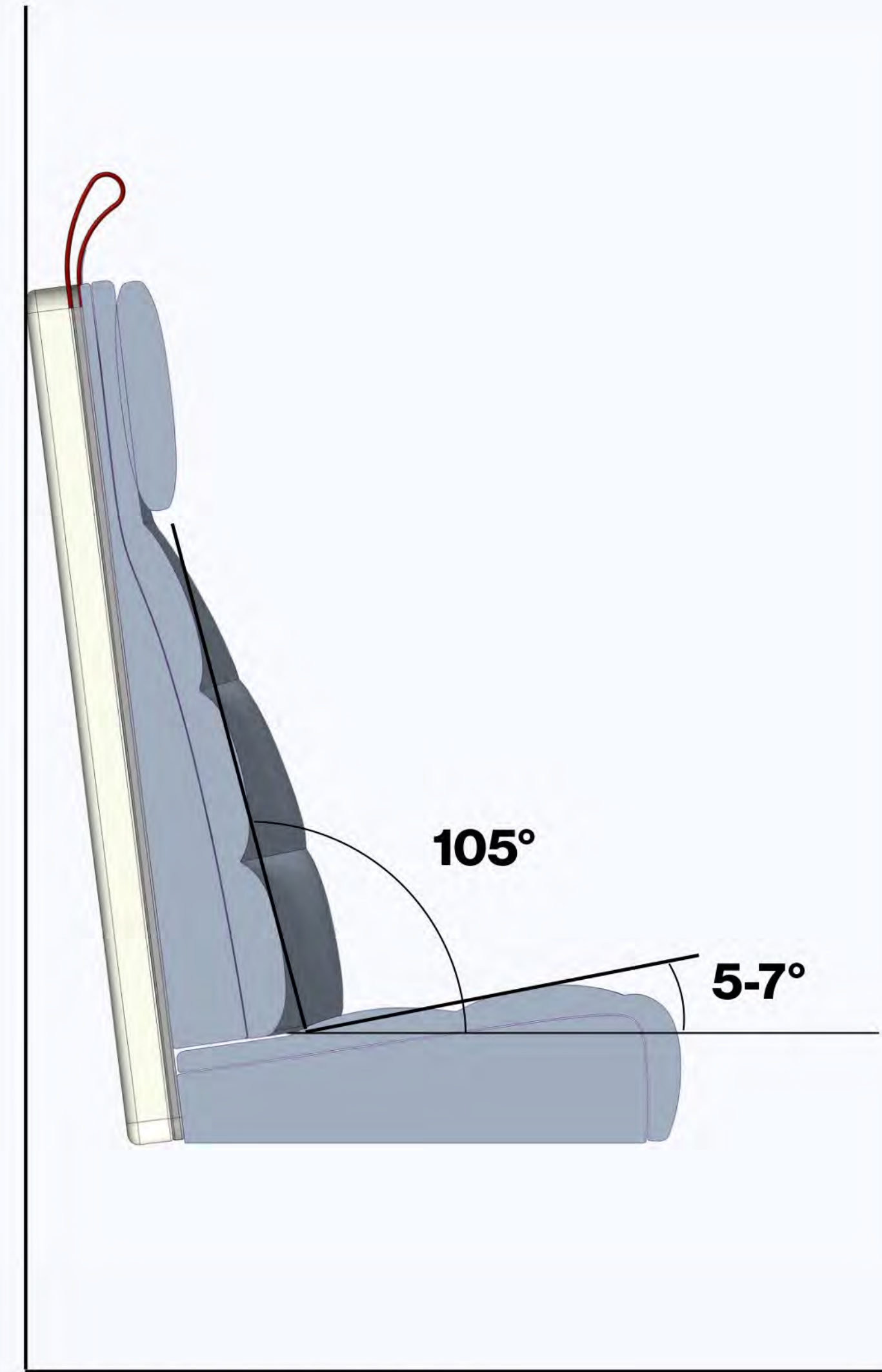

DRAWINGS NOT TO SCALE

Solo Suite | Features

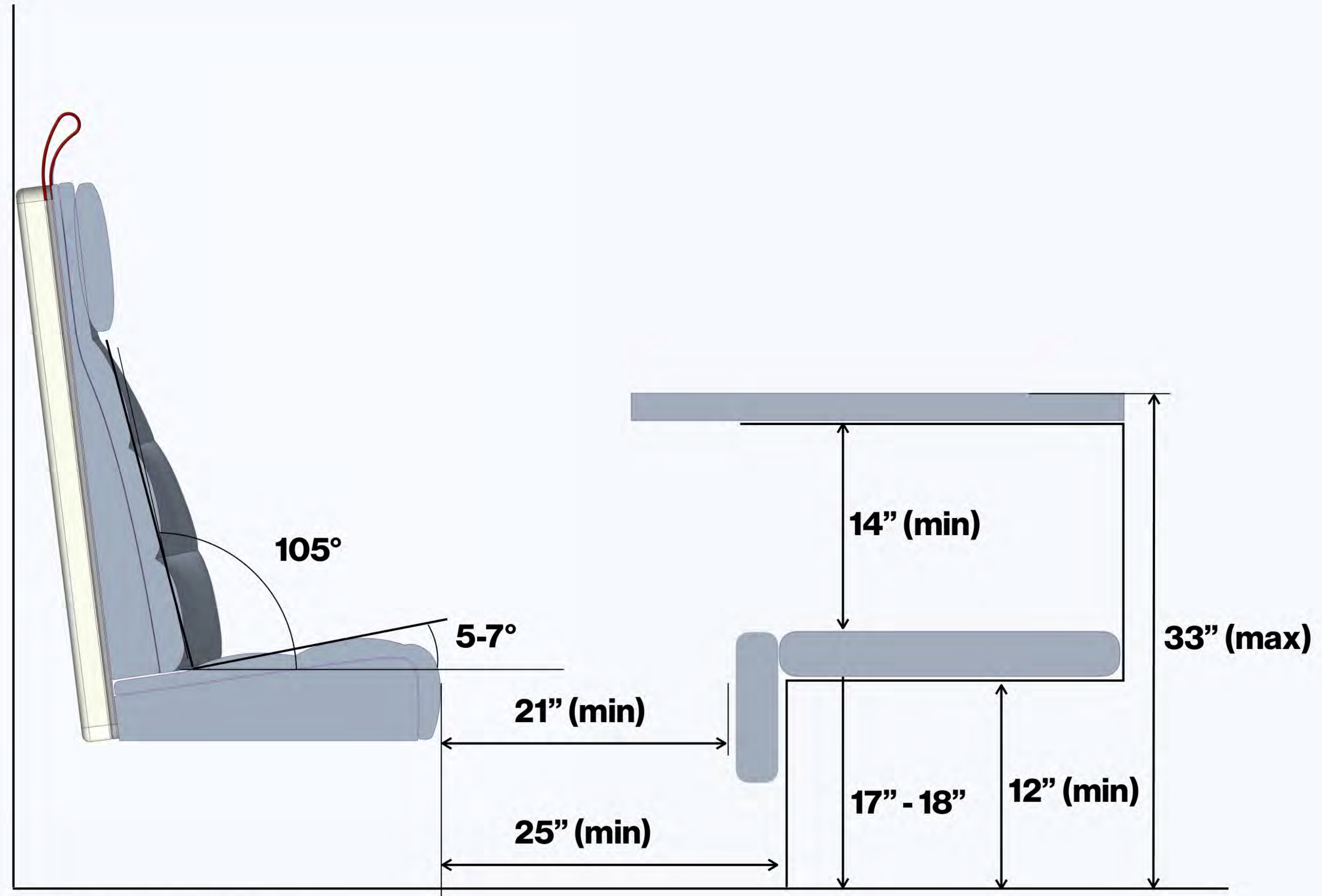

DRAWINGS NOT TO SCALE

Solo Suite | Features

Seat Tracking
Seat should track forward so customers can utilize the large central table and create some recline in the seat.

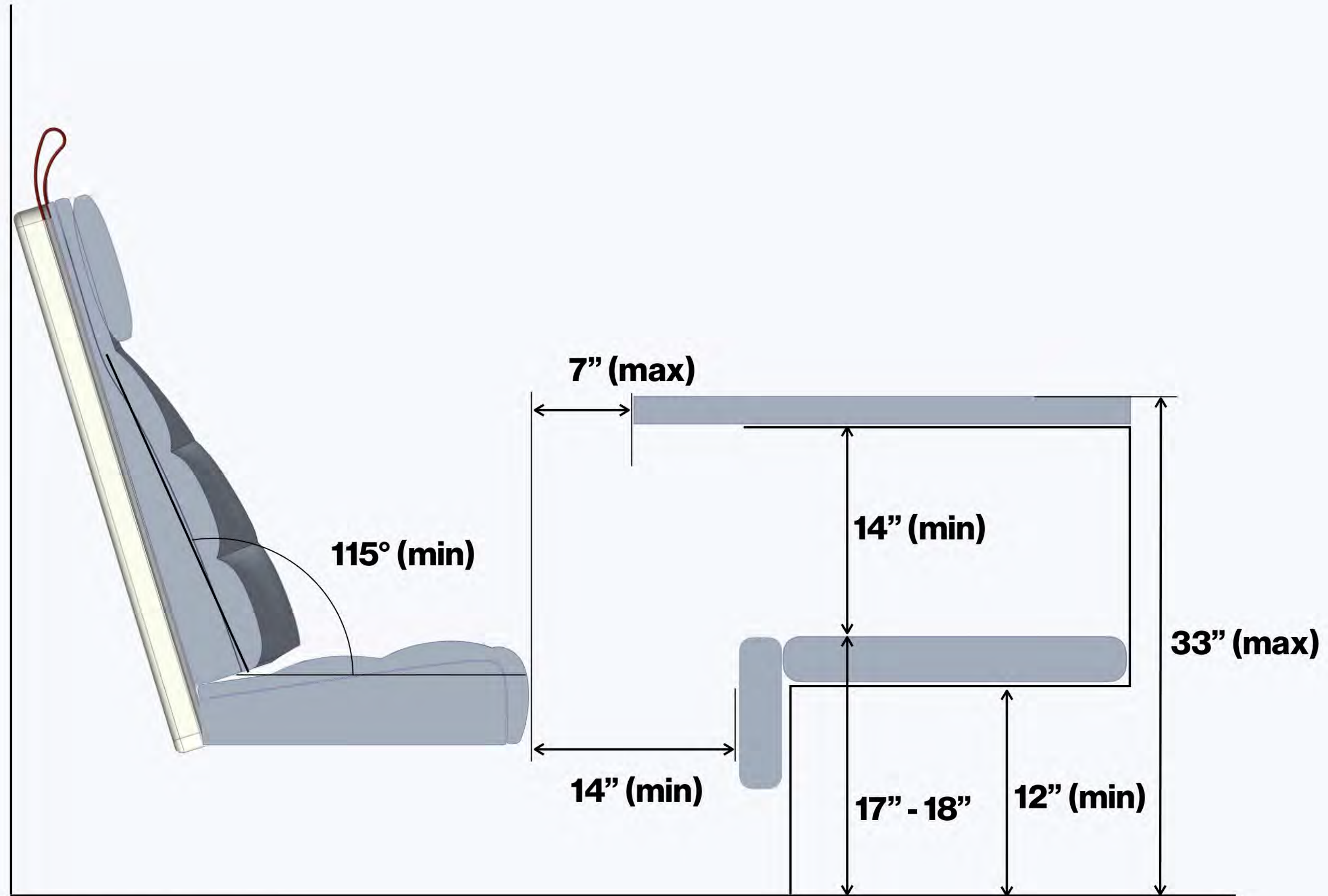

DRAWINGS NOT TO SCALE

Solo Suite | Storage

Solo Suite | Storage

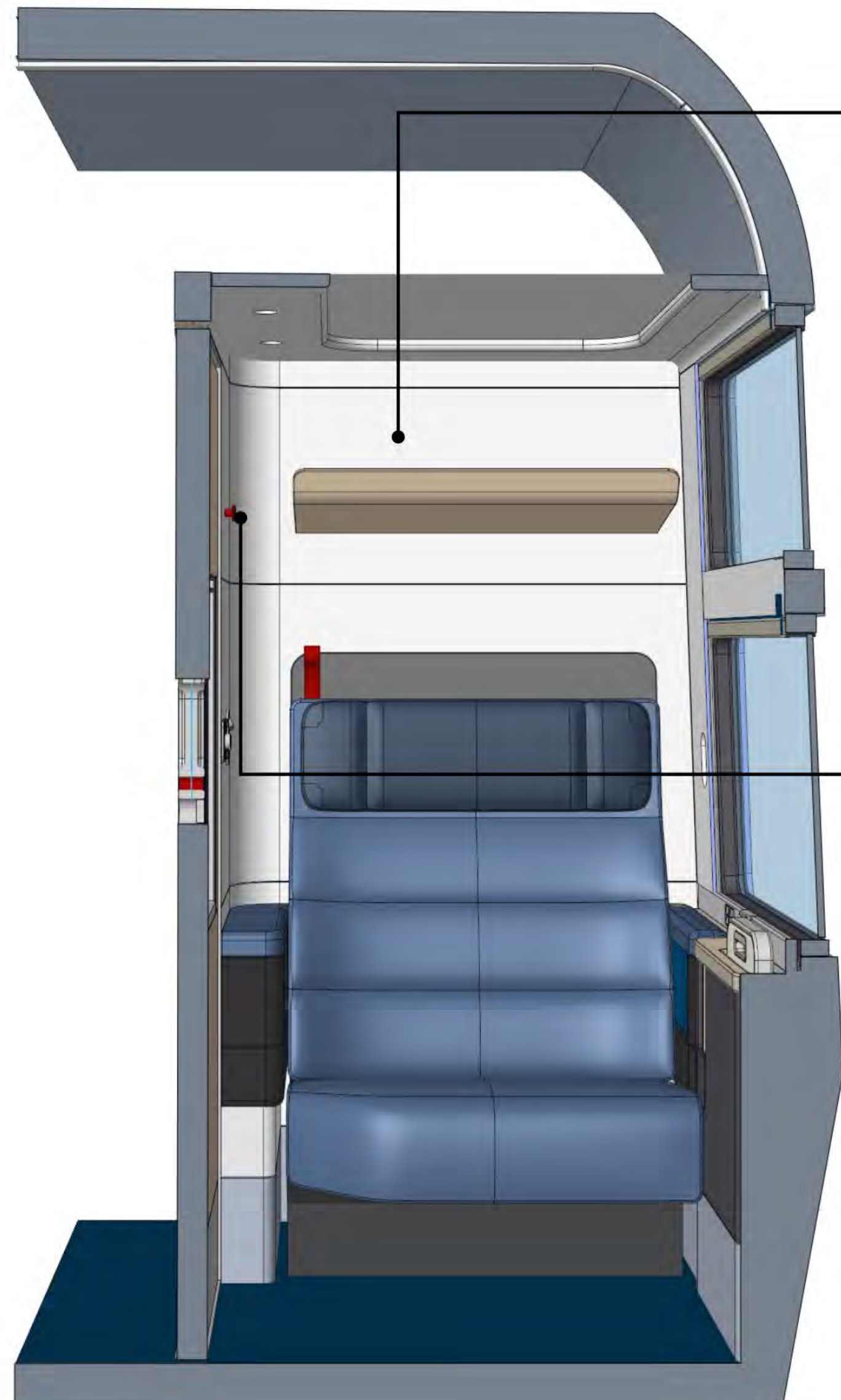

Seat Side

Luggage Rack

Luggage rack for clothes and/or small carry on luggage. The rack should be design to prevent luggage falling off in typical railroad conditions i.e. with lip or retention strap.

Vanity Cabinet

Shelved cabinet for toiletries, hand towels and face cloths and bath towel storage and integrated tissue dispenser. Mirror and towel shall be included.

Hanging Space

At least one coat hook should be provided on the inner wall, suitable to hang clothes or provide the function of an open wardrobe.

Ottoman Stowage

Space under the opposite passenger's ottoman should remain free for carry on luggage. The carry on luggage shouldn't encroach into the door space.

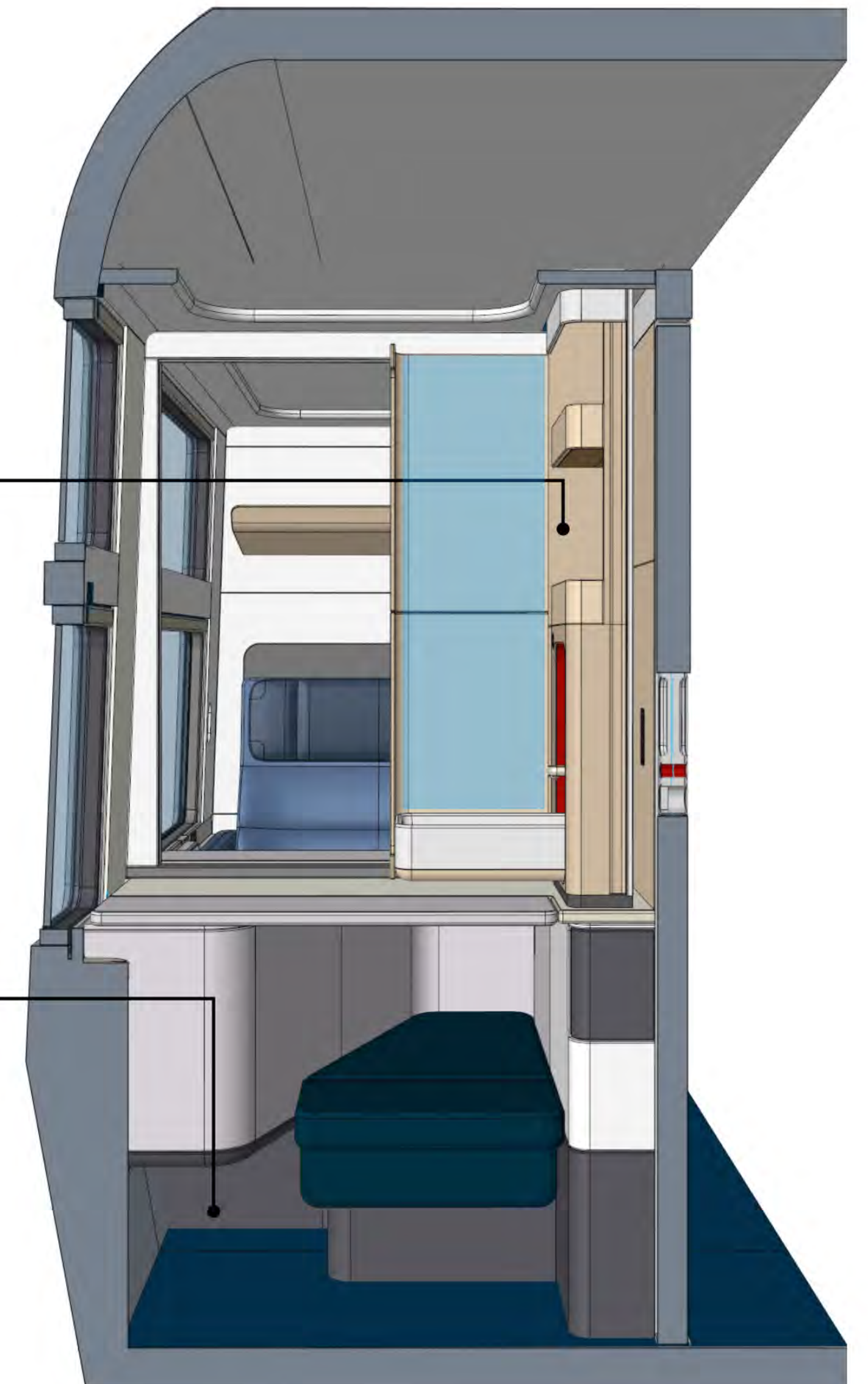

Ottoman Side

Solo Suite | Storage

Armrest storage
Available space on each side of the seat shall be provide storage for personal items and water bottles.



Solo Suite | Seat to Bed Conversions

Solo Suite | Seat to Bed Conversions

Ottoman Table

Table leaf fold up to create knee space.

Headboard

The armrest and seat side pad should continue and connect to form a thin soft headboard around the back of the seat when the bed for the lower berth is down.

Bed

Conversion of seat to bed should result in an entirely flat bed surface. The mattress surface should be integral to the seat. Seams between the bed surface and ottoman are acceptable if finished with a single thin topper. There should be no movement in the bed structure when fully loaded when the bed is deployed.

Folding Ottoman Pad

A folding ottoman pad should complete the seat surface between bed and ottoman. The pad should be independently operated. Care should be taken in the design and activation to avoid accidental entrapment or mitigate injury through misuse.

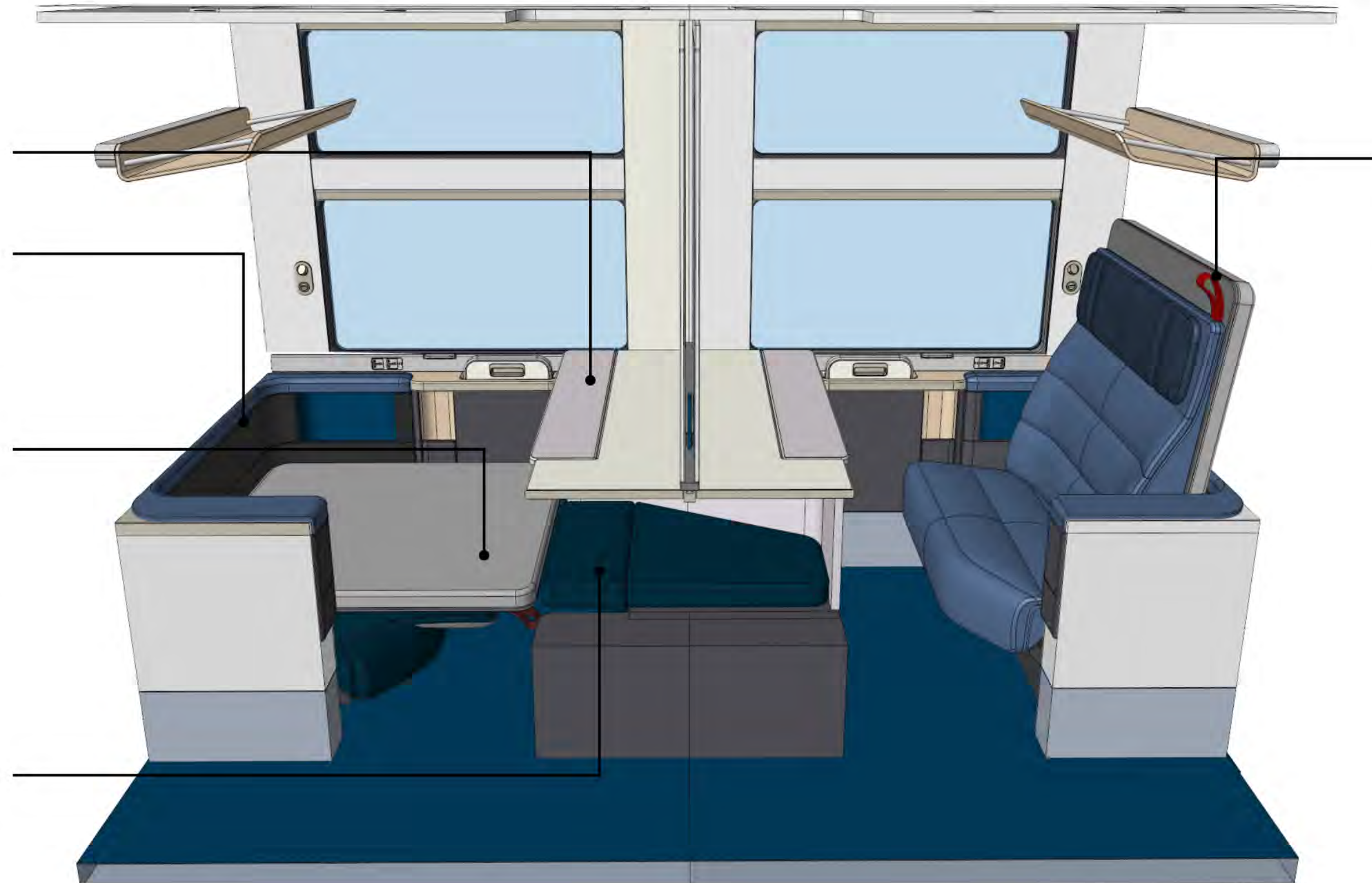

Bed Deployment

A simple unlatch mechanism is required to convert the seats into a lower bed/berth. This should be positioned in a place that is easy for people to use and designed in a way so that people can understand its purpose. The latch should be free from jamming and free from any finger trap hazards.

Standing space

The folding ottoman pad and ottoman table leaf should create a space large enough for passenger to stand and deploy and stow the bed while in the room with the door closed.

Solo Suite | Seat to Bed Conversions

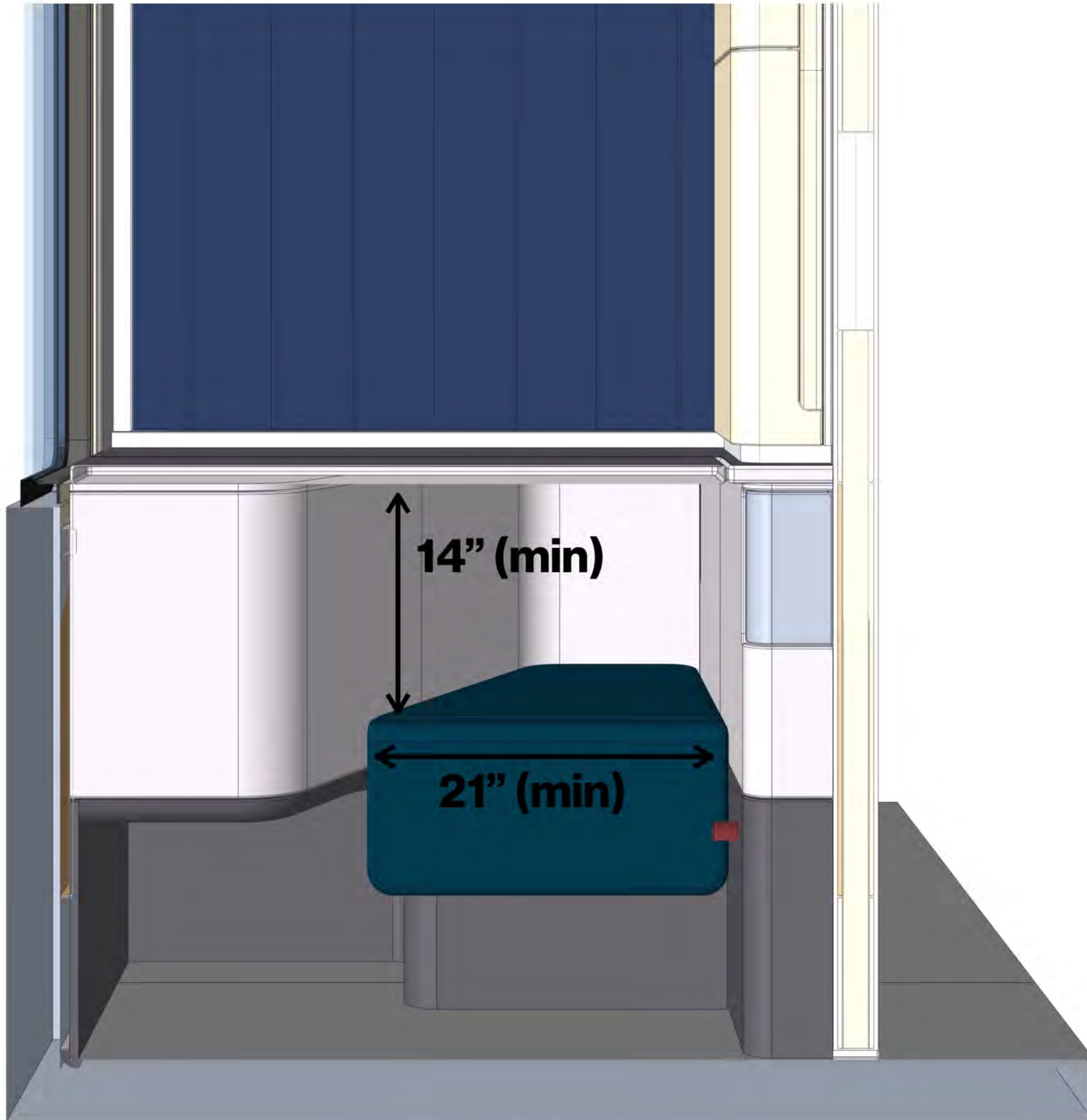

Foot-box threshold

There should be a minimum of 14" between the top of the ottoman/bed surface and the underside of the foot-box/table surface. There should be a minimum of 22" between the two sidewalls at the threshold of the foot-box.

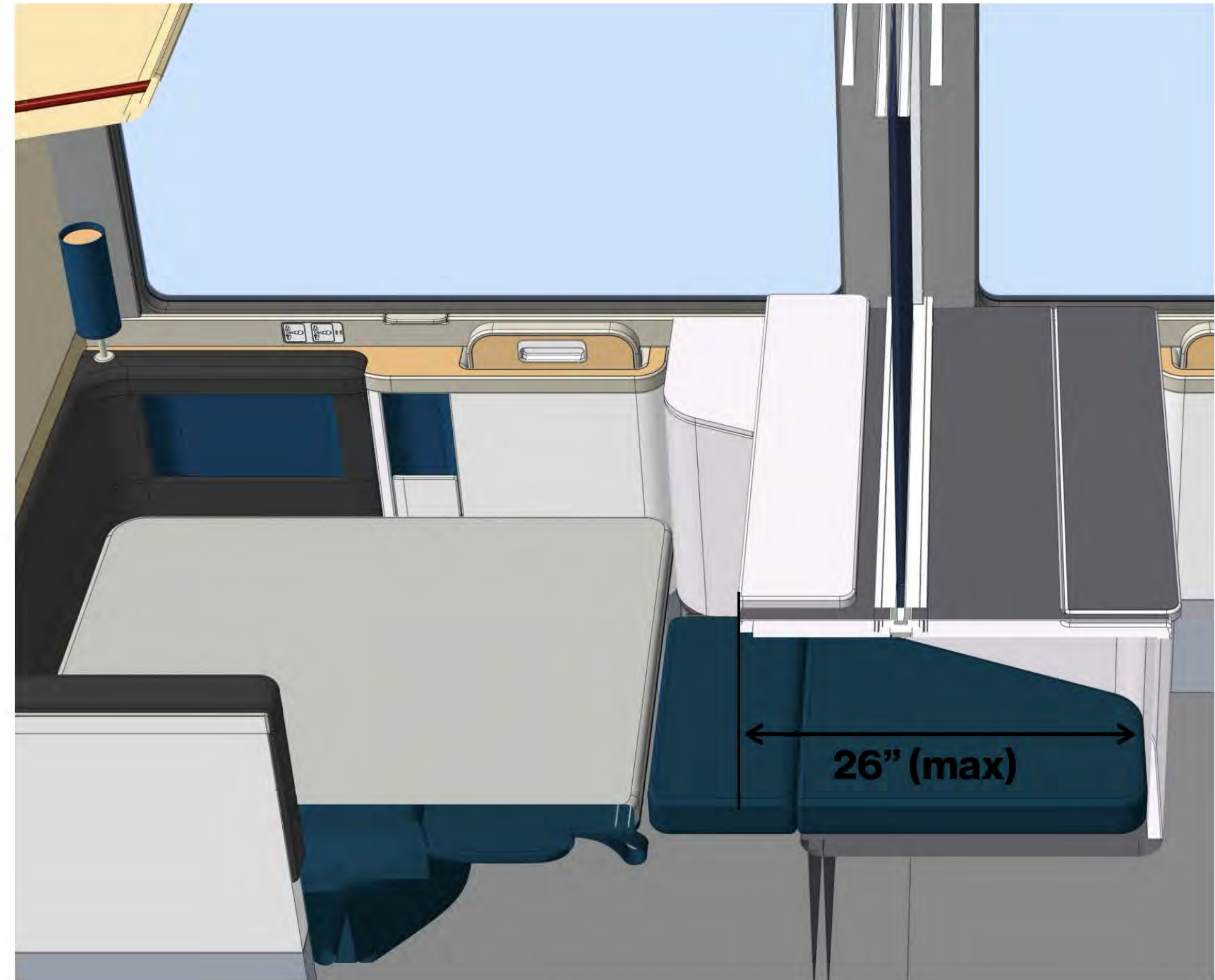

Foot-box depth

The foot-box should be a maximum of 24" deep when the ottoman pad table is folded up.

Solo Suite | Seat to Bed Conversions

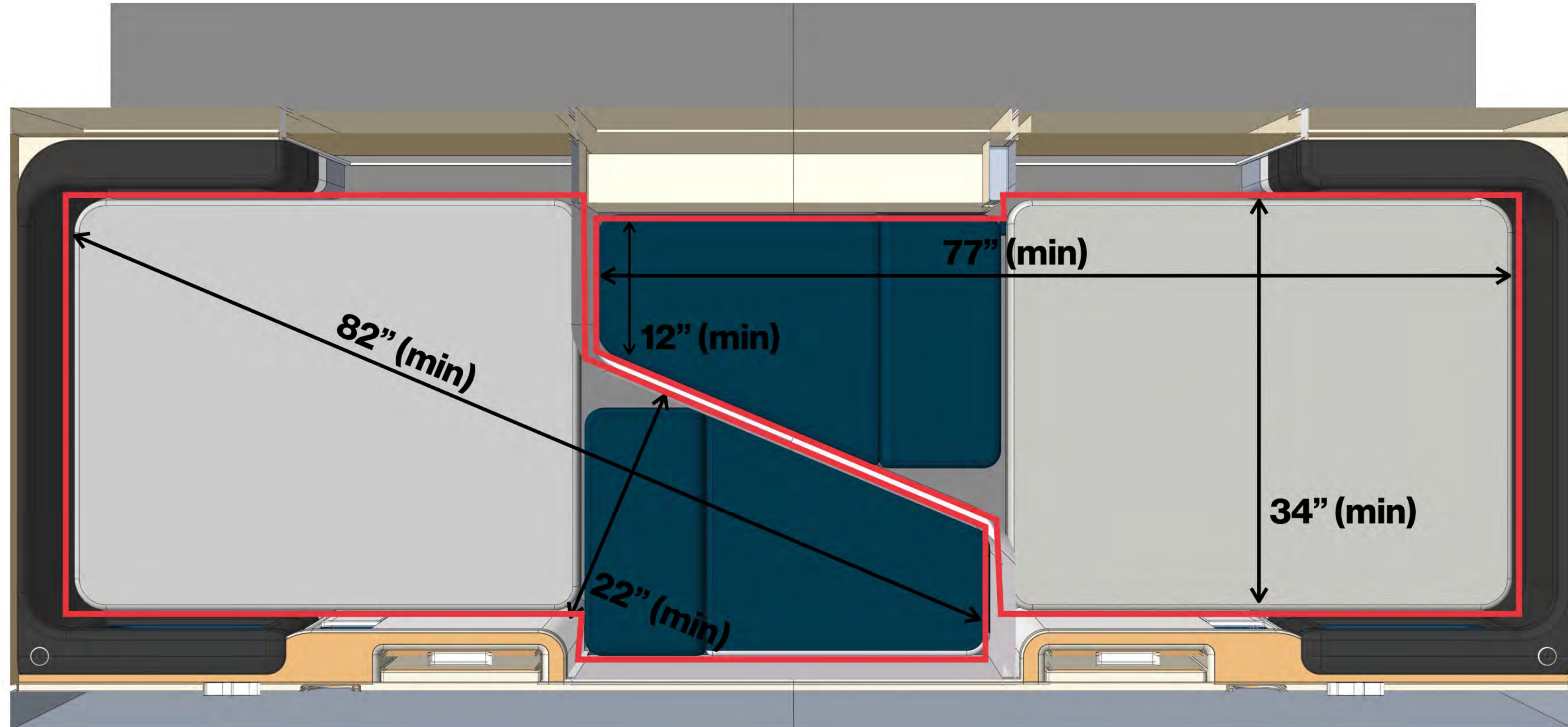

Bed dimensions

There should be a minimum of 82" between the two opposite corners to account for the tapering bed shape.
There should be a minimum of 22" between the inside surface of the foot-box and any sidewall structure.
Dimensions and usability will be subject to Amtrak approval.

Bed dimensions cont.

There should be a minimum of 77" bed length.
There should be a minimum of 34" bed width.
Dimensions and usability will be subject to Amtrak approval.

Solo Suite | Connecting Rooms

Solo Suite | Connecting Rooms

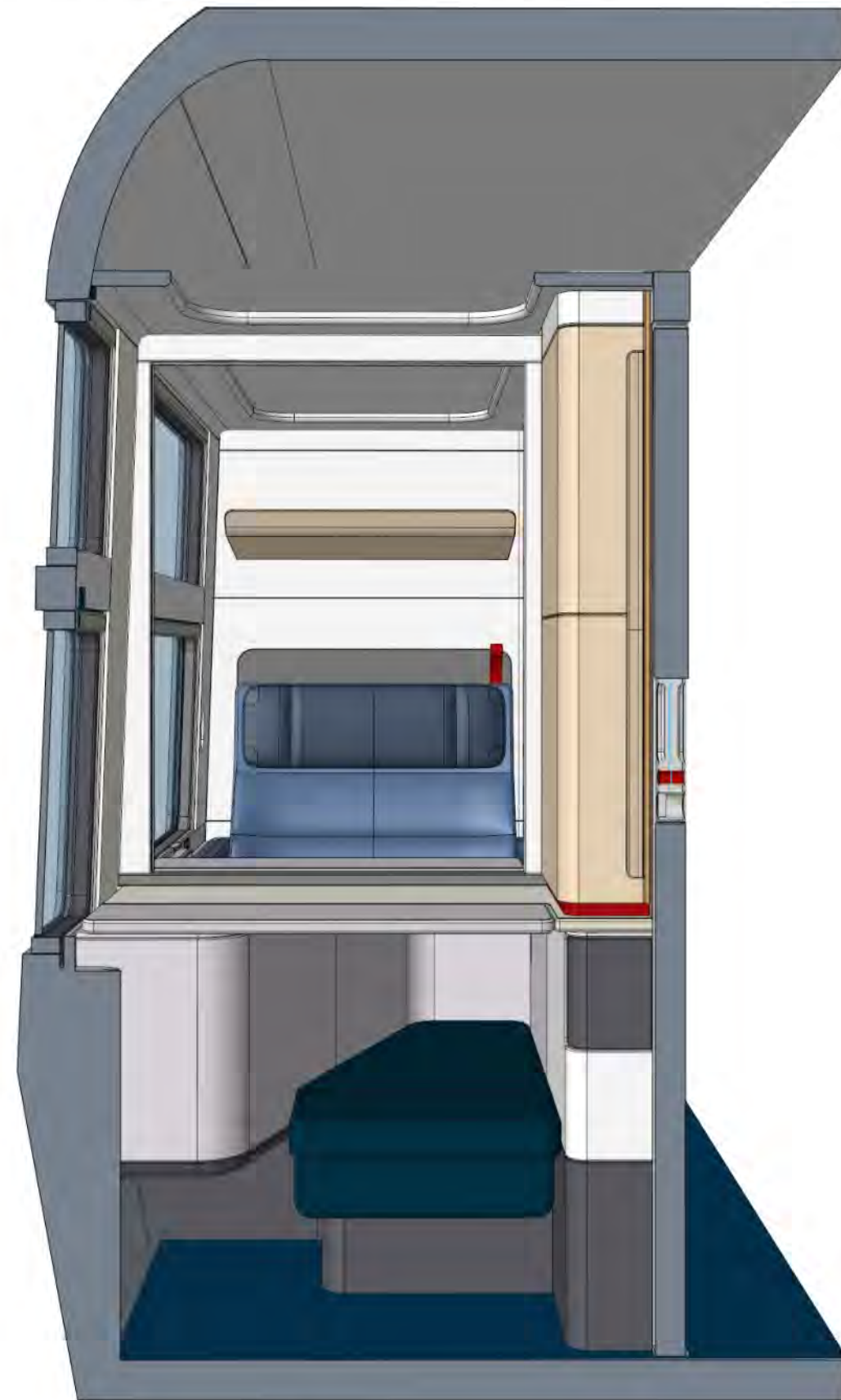

Open (Stowed)

The divider must stow away neatly into a pocket, wall or ceiling and not protrude into the room. When stowed the divider must be free from rattle and movement and be securely retained in its stowed position. The opening should be maximized and be a minimum of 35" x 35". The stowed divider must not prevent the use of any other of the room's features or obscure the window or skylight.

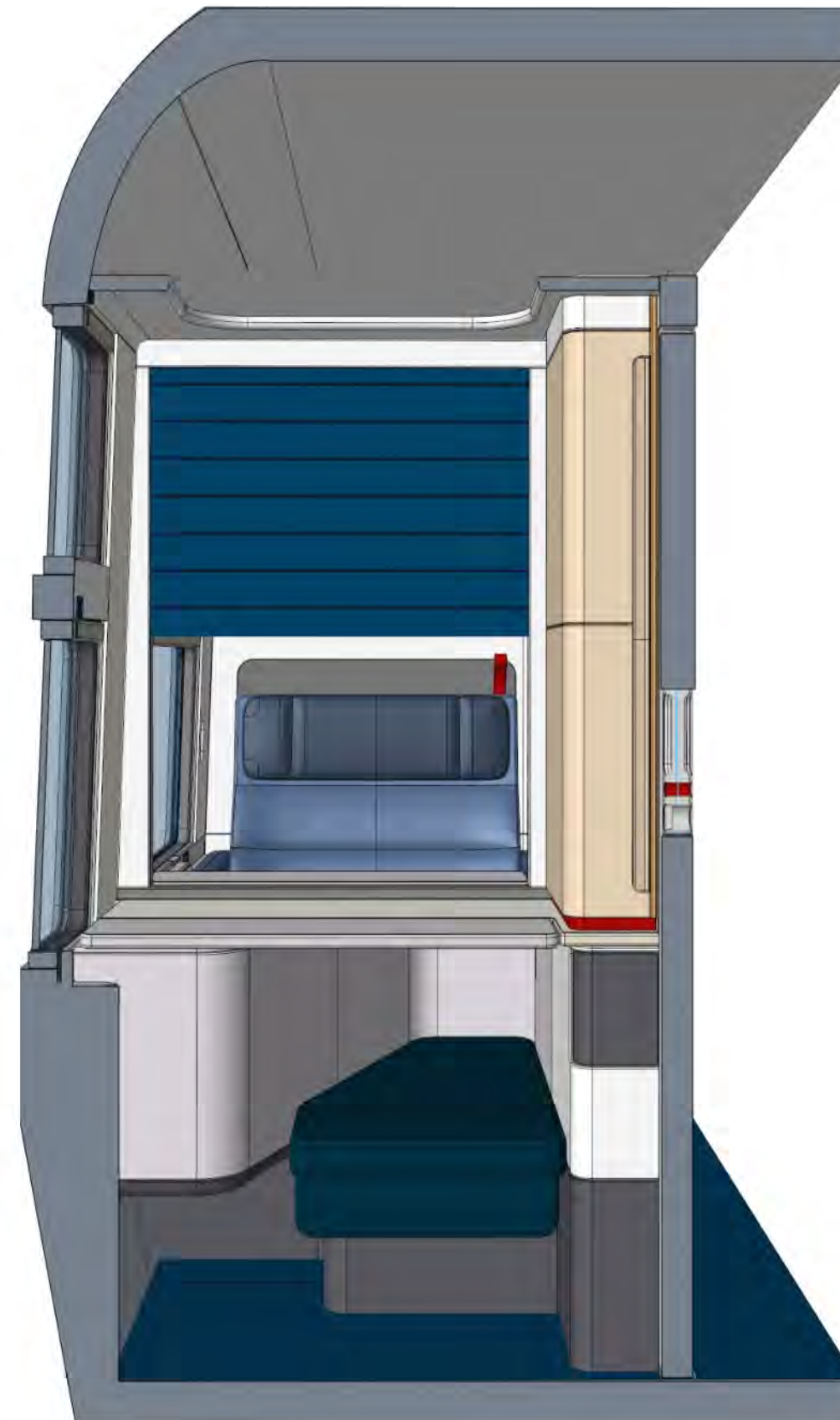

Deployed

As the divider is deployed it must be done with a smooth and gliding motion, with little or no noise. The deployment of the divider should be easy to use and be able to be operated safely by passengers independently.

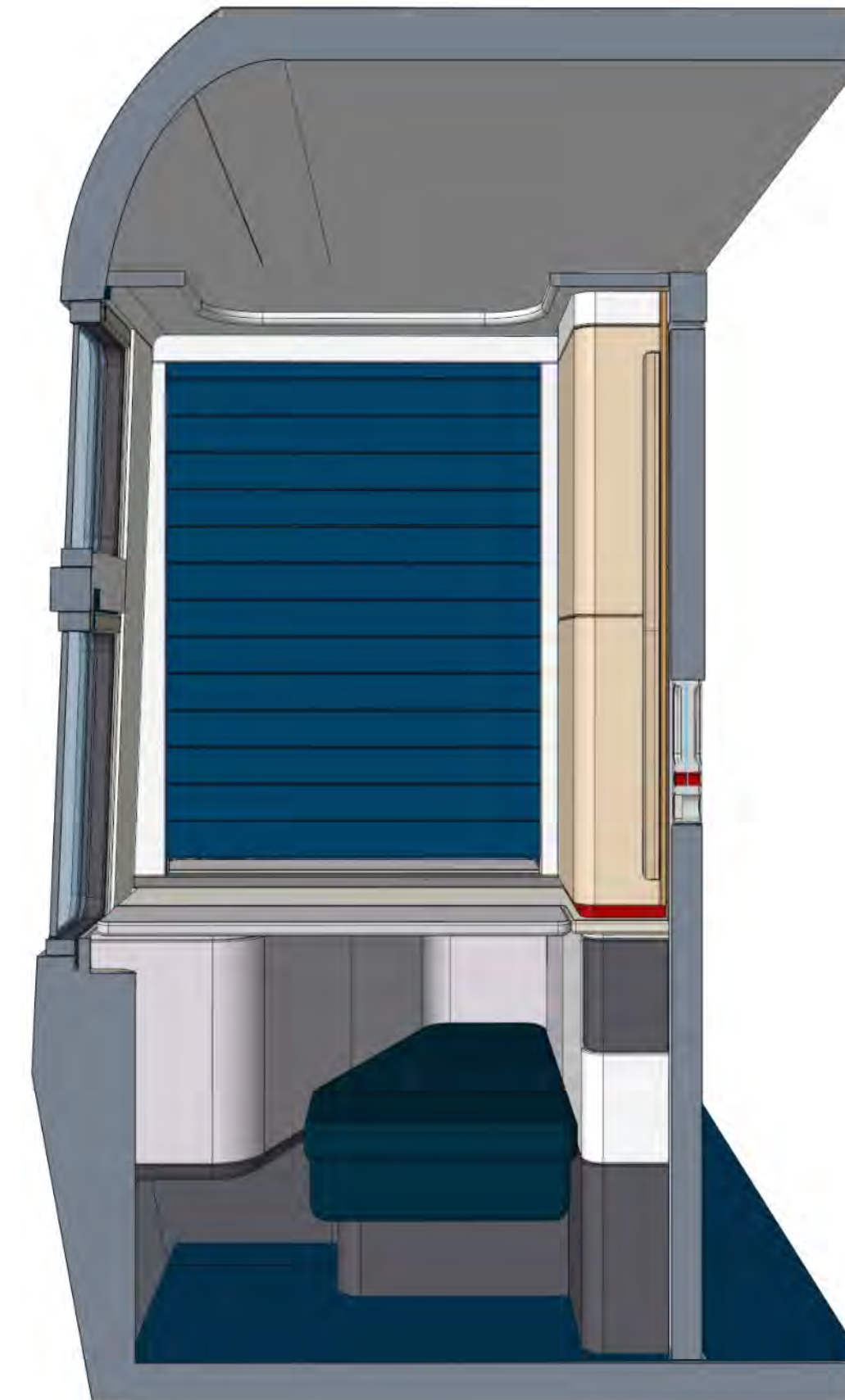

Closed

When divider is in its closed position it must provide good sound insulation to the adjoining room, no less than that of a normal module wall. The divider must be securely locked in place with a visual indicator on both sides of the room to show that it is locked. A solution must be found to prevent one passenger opening the divider without the other's permission, such as a double latch.

When closed the divider must be free from rattle and movement and be securely locked in place along all edges. There should be no light spill from the adjoining room.

Solo Suite | Lighting

Solo Suite | Lighting

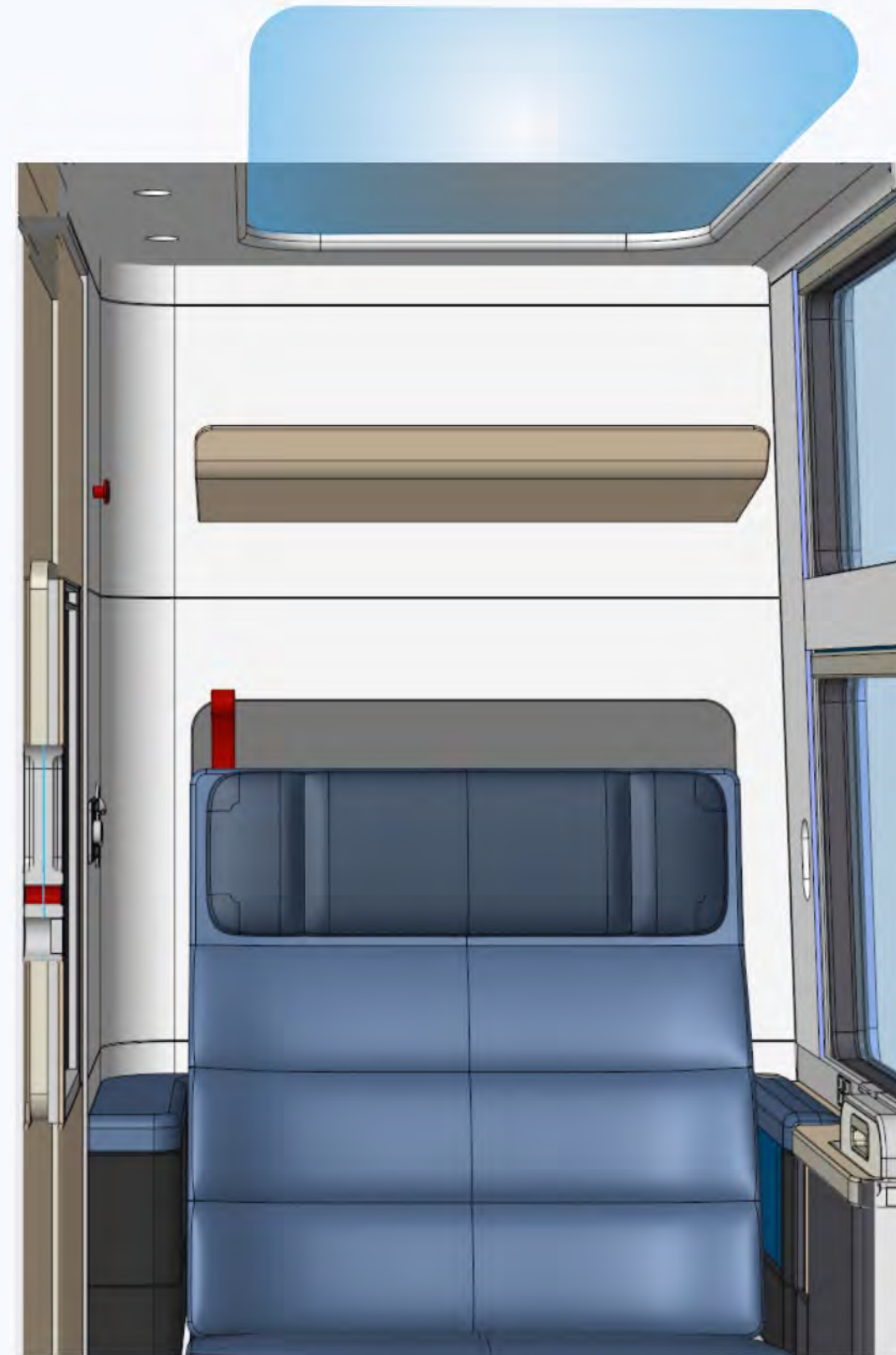

Master Ceiling Light
Central light well acts as master ceiling light.

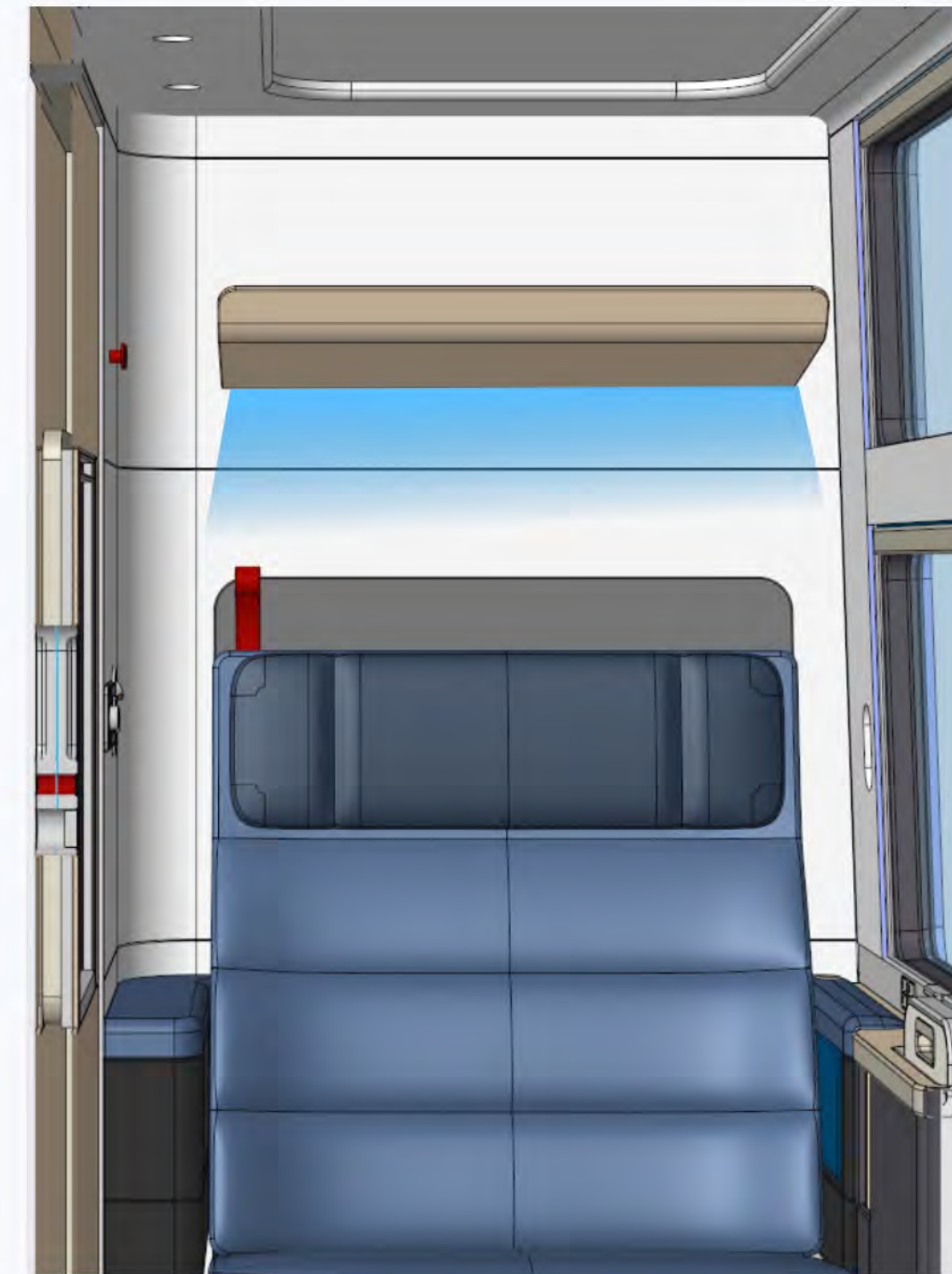

Rack Wash Lights
Indirect wash light running across the width of the room behind the luggage rack

*See lighting spec for detailed definition

Solo Suite | Lighting



Lower Reading Lights

Reading lights should be provided at the seated location. People should be able to adjust the direction and position the light over their lap and in a suitable way to read a book at night. Switches should be located near or on the light.

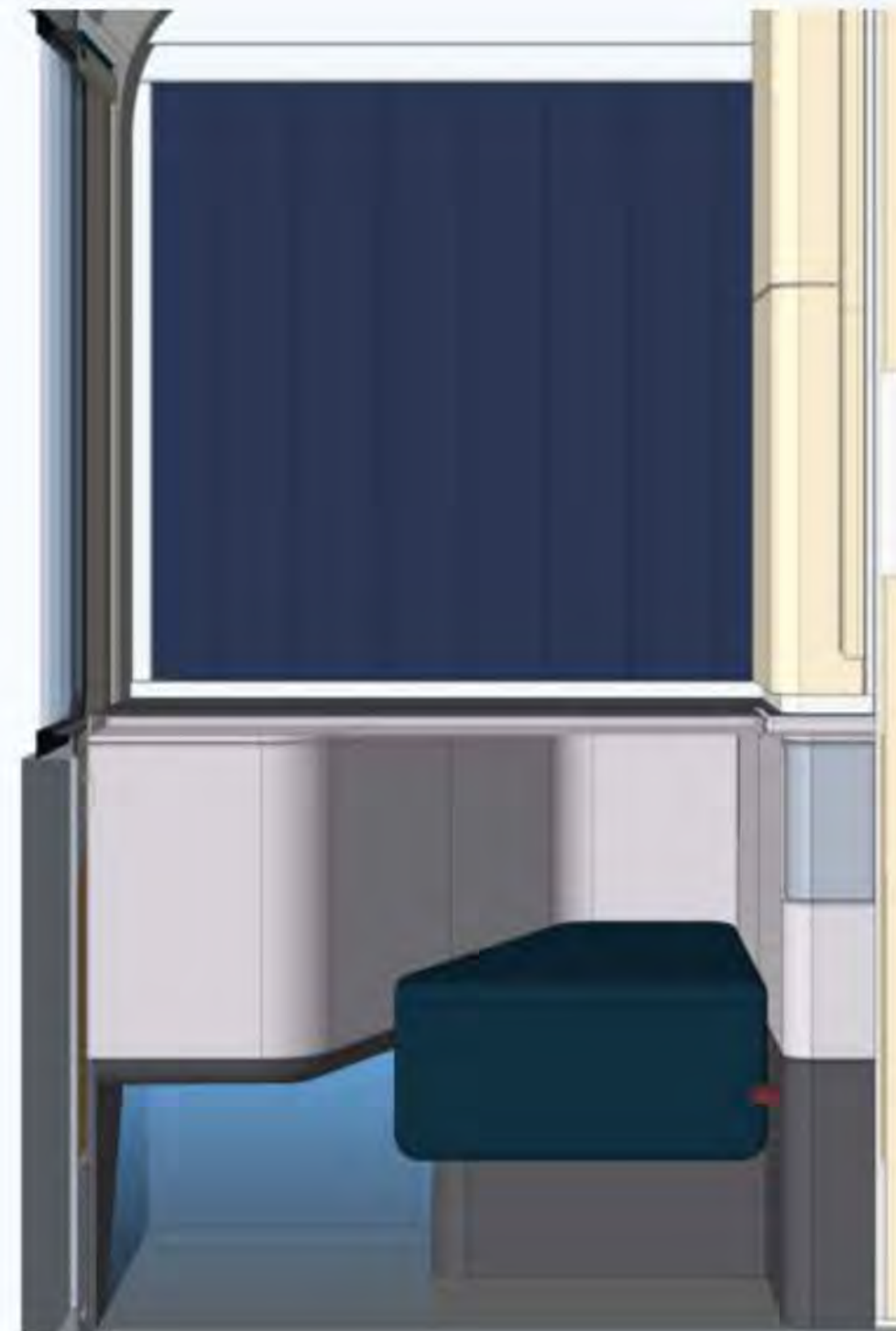

Under Ottoman Light

Indirect light provides additional light well inside luggage stowage area.



Foot-box light

Indirect light provides additional light well inside the foot-box.

*See lighting spec for detailed definition

- Coach Areas
- Sleeper Bedrooms**
- Food & Beverage
- Toilets & Showers
- Common Use Areas
- Crew Areas

Amtrak® Long Distance Product Features

06 | Club Bedroom

Club Bedroom | General

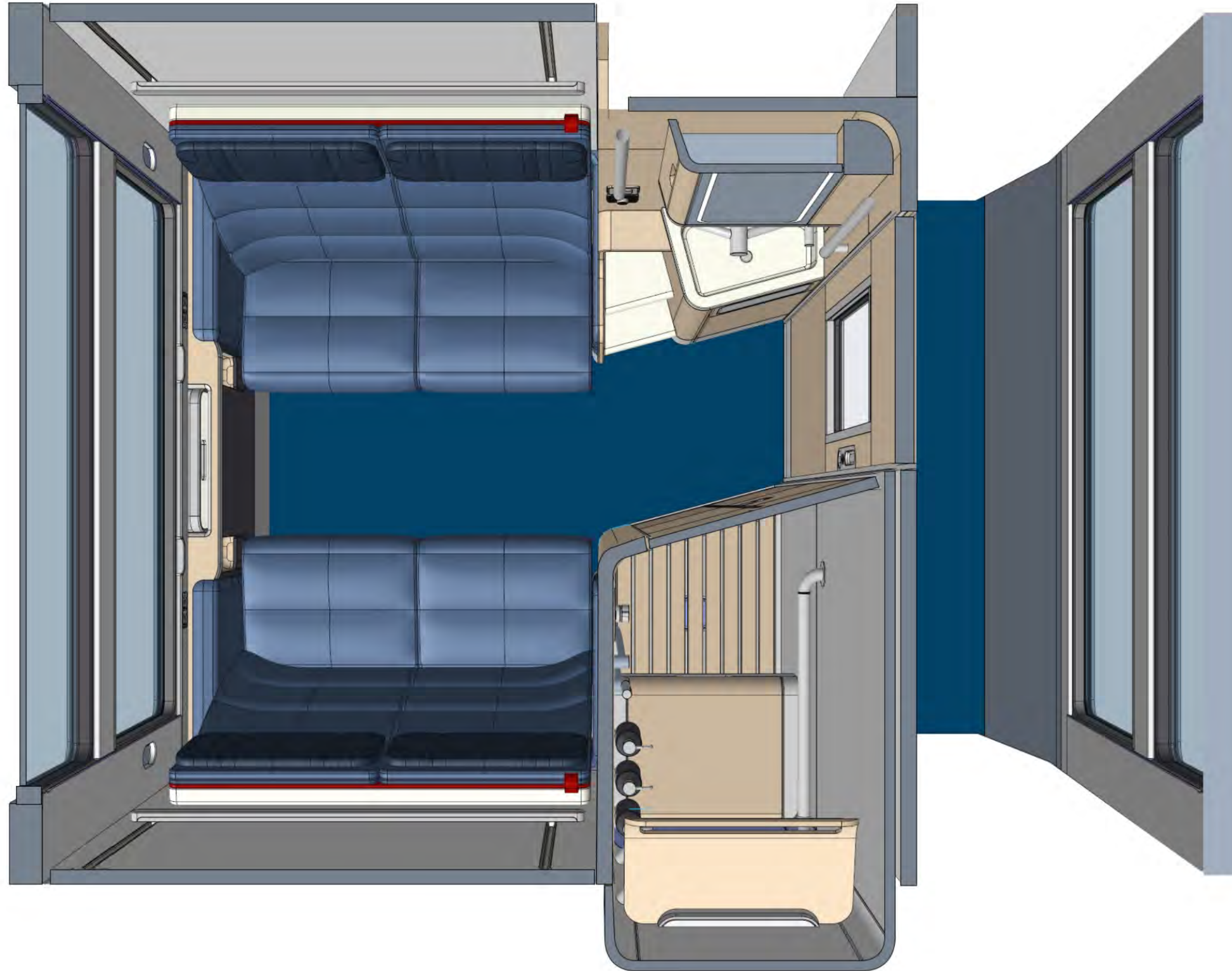

The Club Bedroom

The Club Bedroom should be designed to be a great bedroom for two but also suitable for four people to sit and sleep together. The room should work alongside a 32" accessible aisle. The room comes equipped with a vanity sink and an ensuite toilet and shower.

Club Bedroom | General

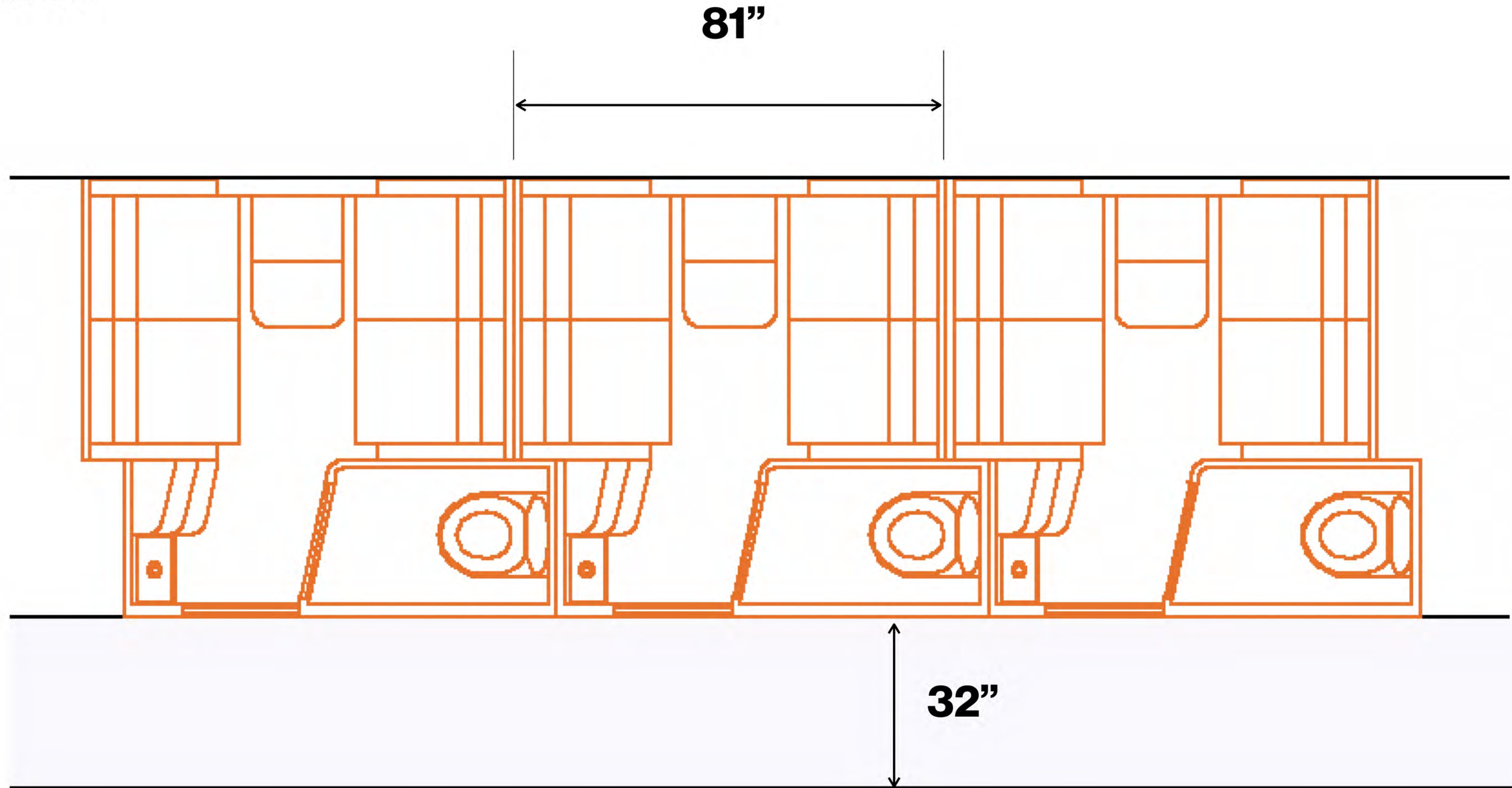

Modules

Modules are 81" in length. Rooms are pitched at 81". The toilets are offset allowing central access to the bedroom.

Aisle Requirements

Works in combination with a 32" accessible aisle

Club Bedroom | Features

Club Bedroom | Features

Seat Headrests
Seat headrests should be adjustable in height for a range of people sizes. There should be four headrests in total. They should have adjustable wings that fold outwards to adjust the width of the headrest.

Seat Comfort
Seat cushions should be contoured to aid seat comfort.

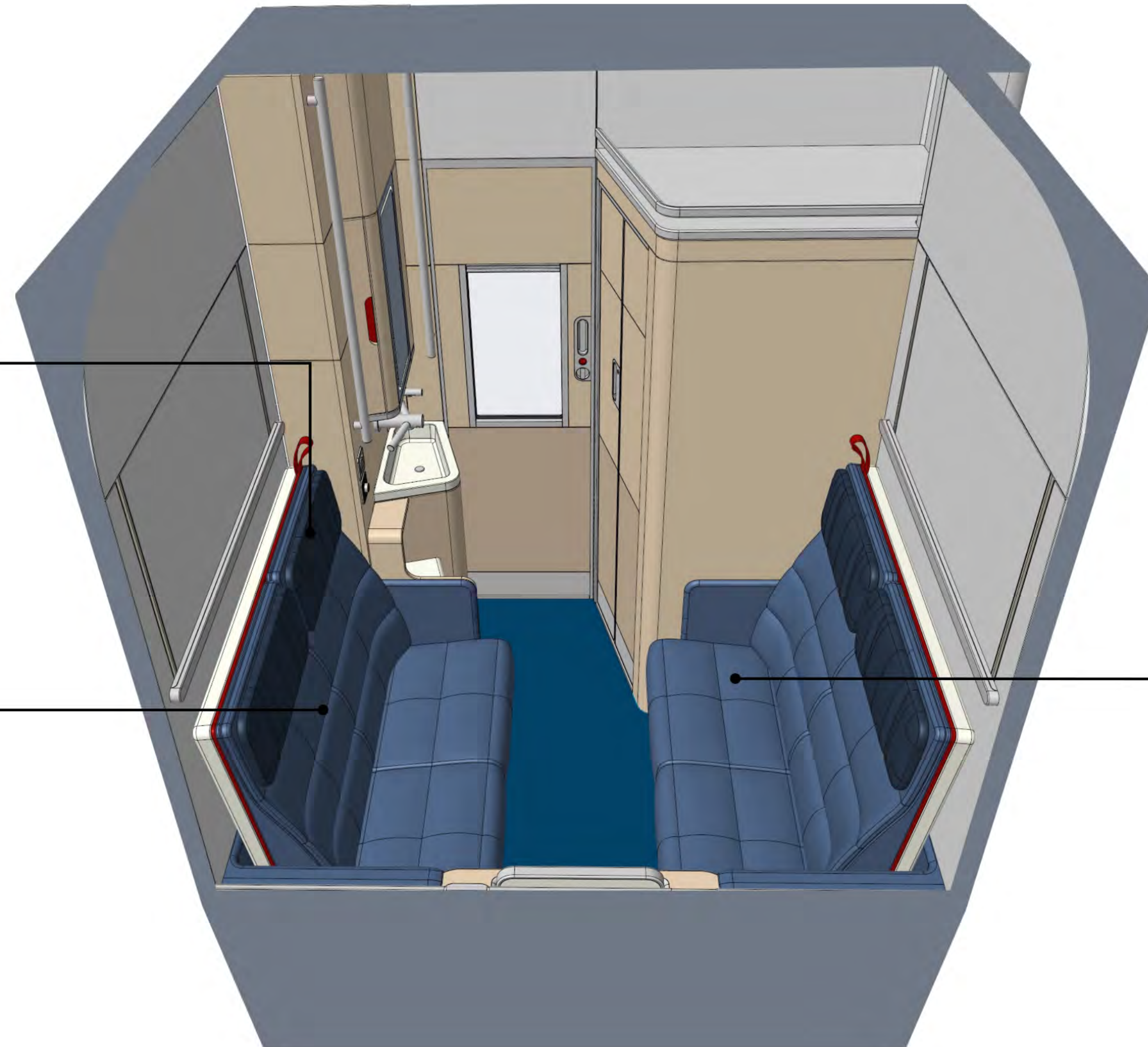

Seats
The Club Bedroom should have four comfortable seats which should also act as two wide couches so people can spread out.

Club Bedroom | Features

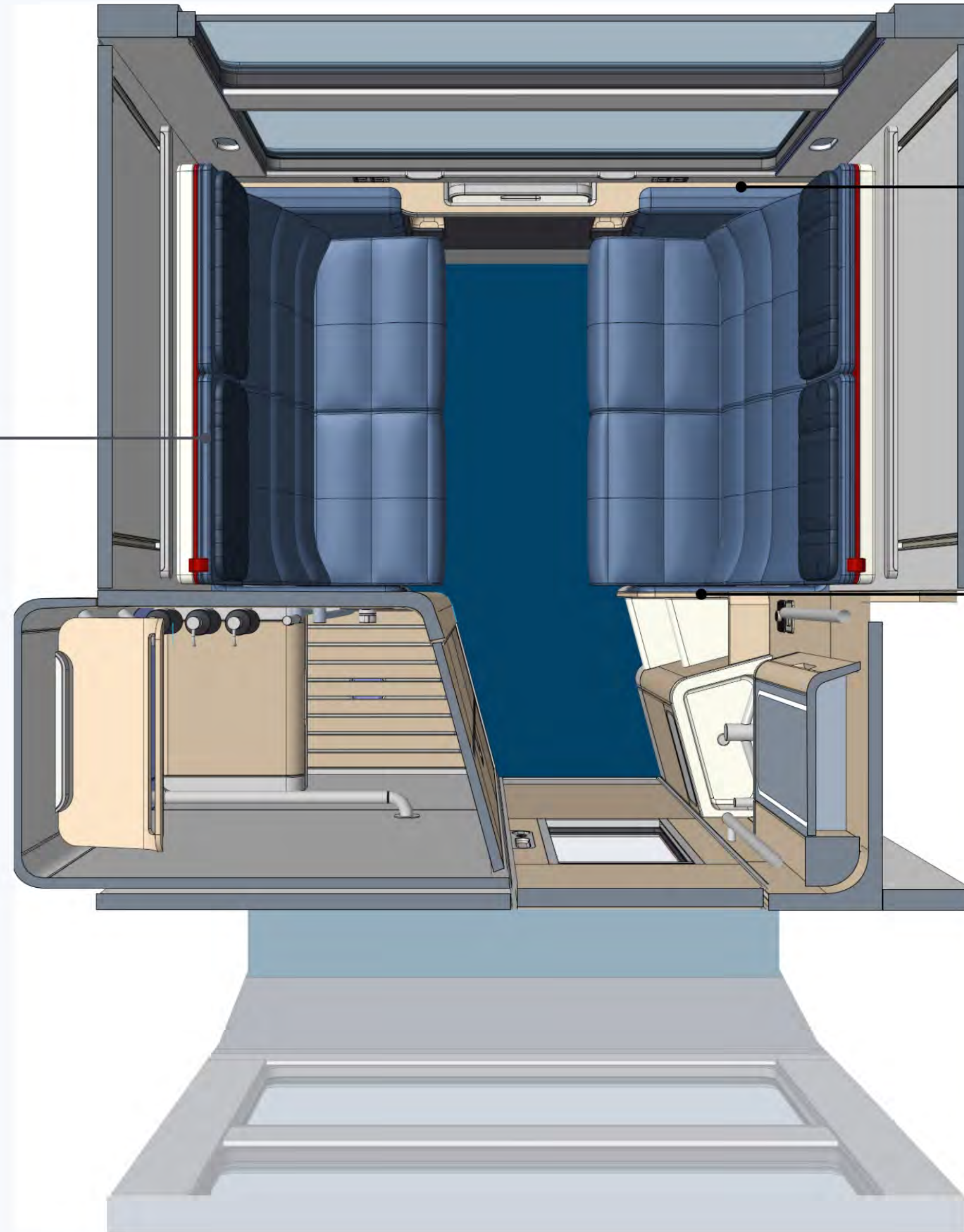

Seat Dimensions

A minimum seat width between inside surfaces of armrests should be a minimum of 48".

Armrest

A full and cushioned armrest of 3.5" should be provided on the window side.

Seat side pad

A soft seat side pad is required on the inside side of the seat to balance the look of the seat and allow some cushioning to the inside edge of the seat and to soften the joining panel work.

Club Bedroom | Features

Seat Dimensions

All seat dimensions, cushion density/ shore hardness will be subject to mockup review and approval by Amtrak

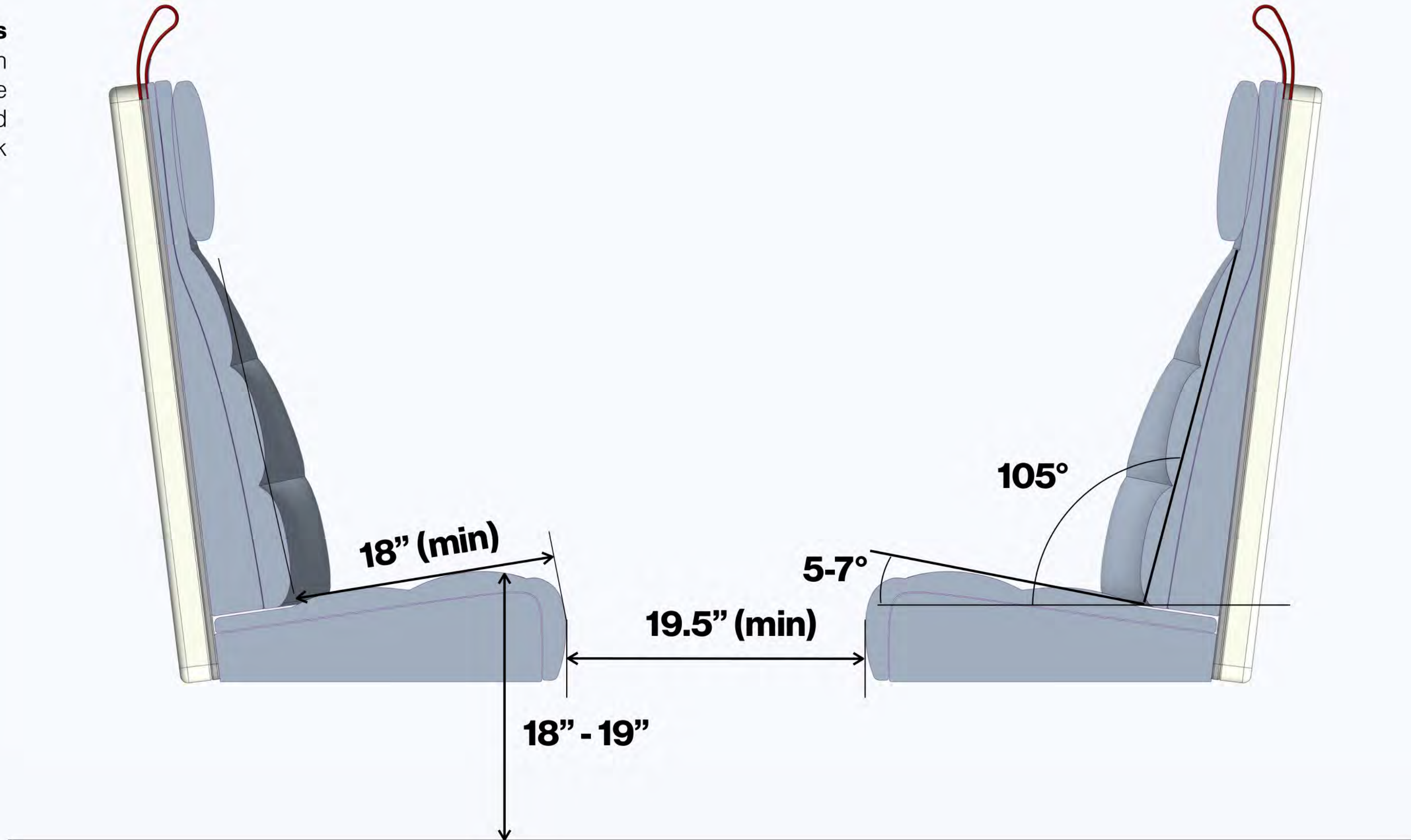

Club Bedroom | Features

Cup Holders

One for each side for the room located so people can use and access the cupholders from a seated position by the window. They should fold away when not in use.

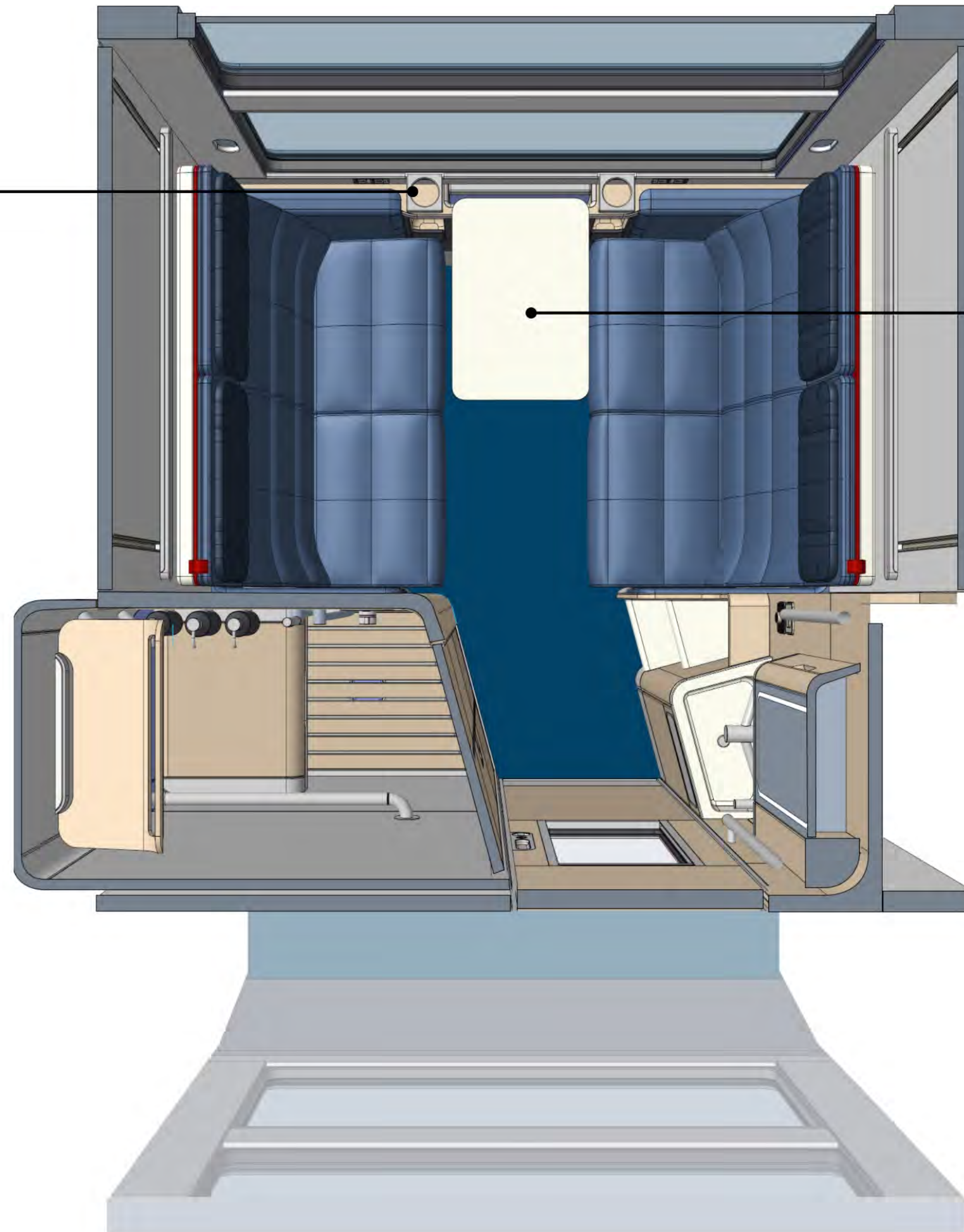

Fold out Table

A single leaf table deployed from side wall should be supplied. The table height should provide good knee clearance for seated people with a height off the finished floor between 27" and 29". The table should be easy to deploy and stow with an intuitive handle.

Club Bedroom | Features



Blinds

A single pull-down blind system shall be provided per window, capable of delivering both daytime solar/glare control and full blackout performance.

Window and Window Mask

Window and window mask should be central to the room and overall window size maximized.

At Seat Power

Two power sockets and Two USB sockets should be provided at each seated location by the window.

Cubbies

Cubbies shall be built into available space for stowage of personal items.

Club Bedroom | Features

Power Outlets

Two power sockets and two USB sockets shall be positioned the by the vanity area.

Master Light Switch

Master light switches to be positioned near door.. A second master switch sets a preset condition in the toilet/shower room. A second bank of master switches should be safely accessible by a person in the top bunk.

Temperature Control

Trash

A trash bin should be provided below the sink. Access to the bin should be provided via a swing door. The bin should be watertight in case of a spill to prevent any water escapement.



RH Side



LH Side

Power Outlets

Two power sockets and two USB positioned by the open wardrobe within easy access of seated passengers.

Club Bedroom | Features

Automatic Water Faucet

Water is automatically dispensed when hands are placed under the faucet. A physical element should be visible so it is clear where water is dispensed from. Water pressure, water flow should not create any water splash or spill outside of the sink area.

Soap Dispenser

An automatic soap dispenser should be included above the sink area. A physical element should be present to indicate how and where the soap will dispense.

Automatic Hand Drier

An automatically triggered hand dryer should be included under the vanity unit. This can be part of the faucet or supplied separately. A physical element should be visible so it is clear how to use the dryer. The dryer should use high velocity air and HEPA filters similar to a Dyson Airblade. The air dryer should not blow water out of the sink.

Sink

The sink should have a marine edge so any water spill is captured in the sink area. A splash back behind the sink should protect the surrounding areas from water splashed onto the back wall from the sink area. An area on the side of the sink should be reserved for a refillable hand lotion bottle fixed to the side wall.



Club Bedroom | Features



Door Window and Blind

Door window should be central to door and come equipped with an integrated black out blind.

Door Handle and Lock

Door handles should be positioned to slide door easily open and closed. An accessible manual lock should be included with an indicator to show lock condition.

Door

Door free from rattle, smooth sliding operation.

Club Bedroom | Storage

Club Bedroom | Storage



RH Side

Vanity Cabinet

Shelved cabinet for toiletries, hand towels and face cloths (4 of each Amtrak's standard towels supplied). Space required for integrated tissue dispenser. Internal light activated as cabinet is opened. Mirror fronted.

Under Seat Stowage

Space under the both seats should remain free for up to four pieces of carry on luggage. No seat mechanism or structure should preclude the ability to store large carry on bags.



LH Side

Club Bedroom | Storage

Upper Cubbies

Cubbies shall be provide storage for personal items where possible at upper bunk level.

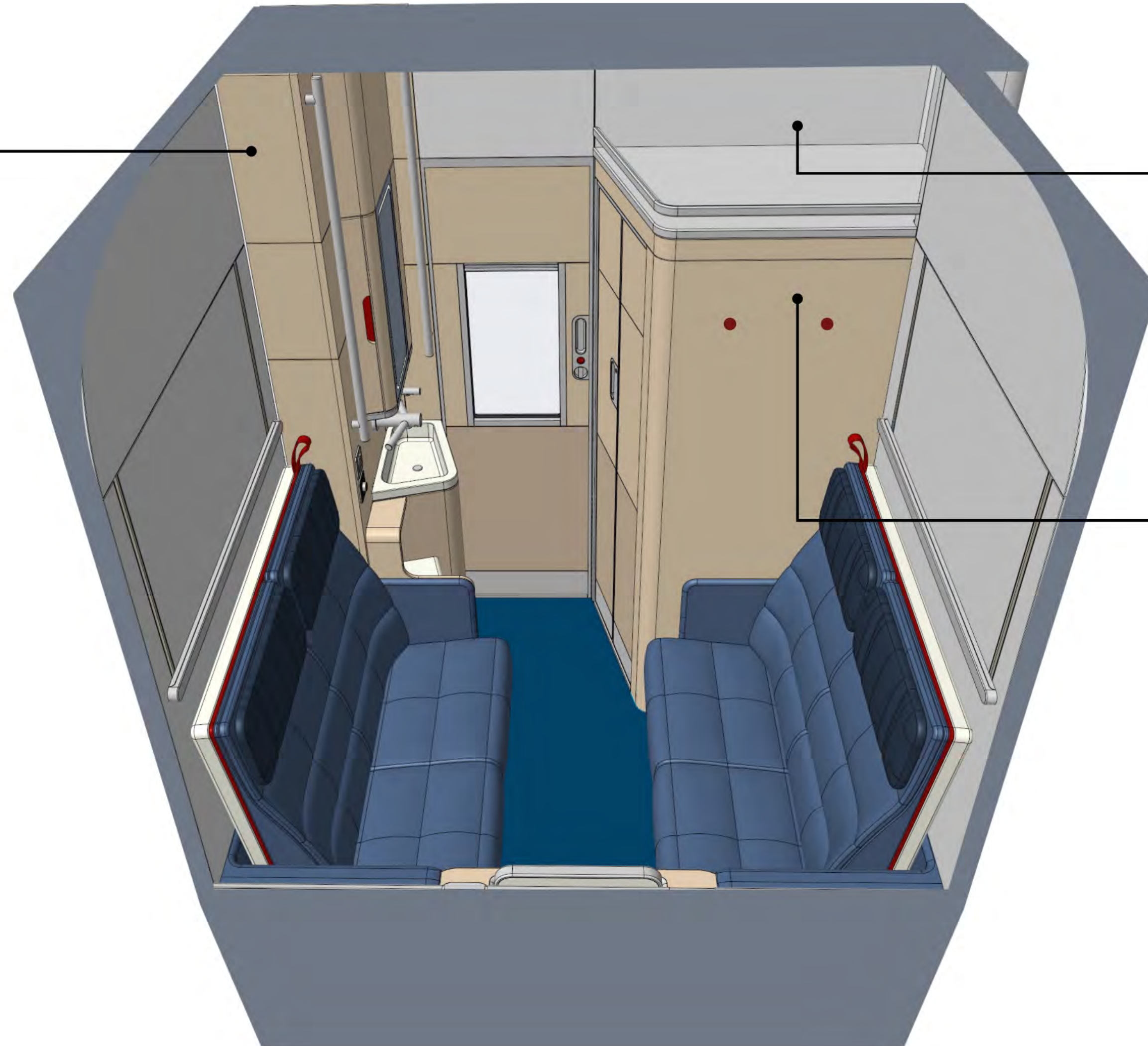

Upper Storage

Upper storage shall be provided for carry on cases above the aisle or bathroom.

Open Wardrobe

At least two coat hooks should be provided within an open wardrobe. The space should be large enough to hang clothes on coat hangers.

Club Bedroom | Seat to Bed Conversions

Club Bedroom | Seat to Bed Conversions



Lower Berth Deployment

A simple unlatch mechanism is required to convert the seats into a lower bed/berth. This should be positioned in a place that is easy for people to use and designed in a way so that people can understand its purpose.

Upper Bunk

Bunk should be stored horizontally in the room. Bunk should not preclude any part of the window when stowed. The bunk's stored height should be optimized in both seated and standing positions.

Upper Bunk Deployment

A simple and easy to use handle, latch and lock mechanism should be within easy reach from a standing position. Successful locking should be visually indicated and safety measures should be put in place to prevent accidental deployment and prevent misuse.

The bunk deployment should be free from jamming and racking and should lower slowly and in a controlled manner. Considerations should be made for assisted movement or counter balances to assist people moving the bunk down and back up into the stowed position.

Club Bedroom | Seat to Bed Conversions

Bunk Retaining Straps

Retaining straps are required to prevent people from rolling out of the bunk. These should retract into the ceiling and be easily pulled down and click into place using an automatic locking retractor belt system (similar to a car seat belt system).



Bunk Height

The bunk height when deployed will be evaluated and judged carefully during the design review process.

The seated area below the bunk should still be usable by seated passengers when the upper bunk is deployed, the area should still be well lit and tables and other amenities should not be restricted by a deployed bunk.

Club Bedroom | Seat to Bed Conversions

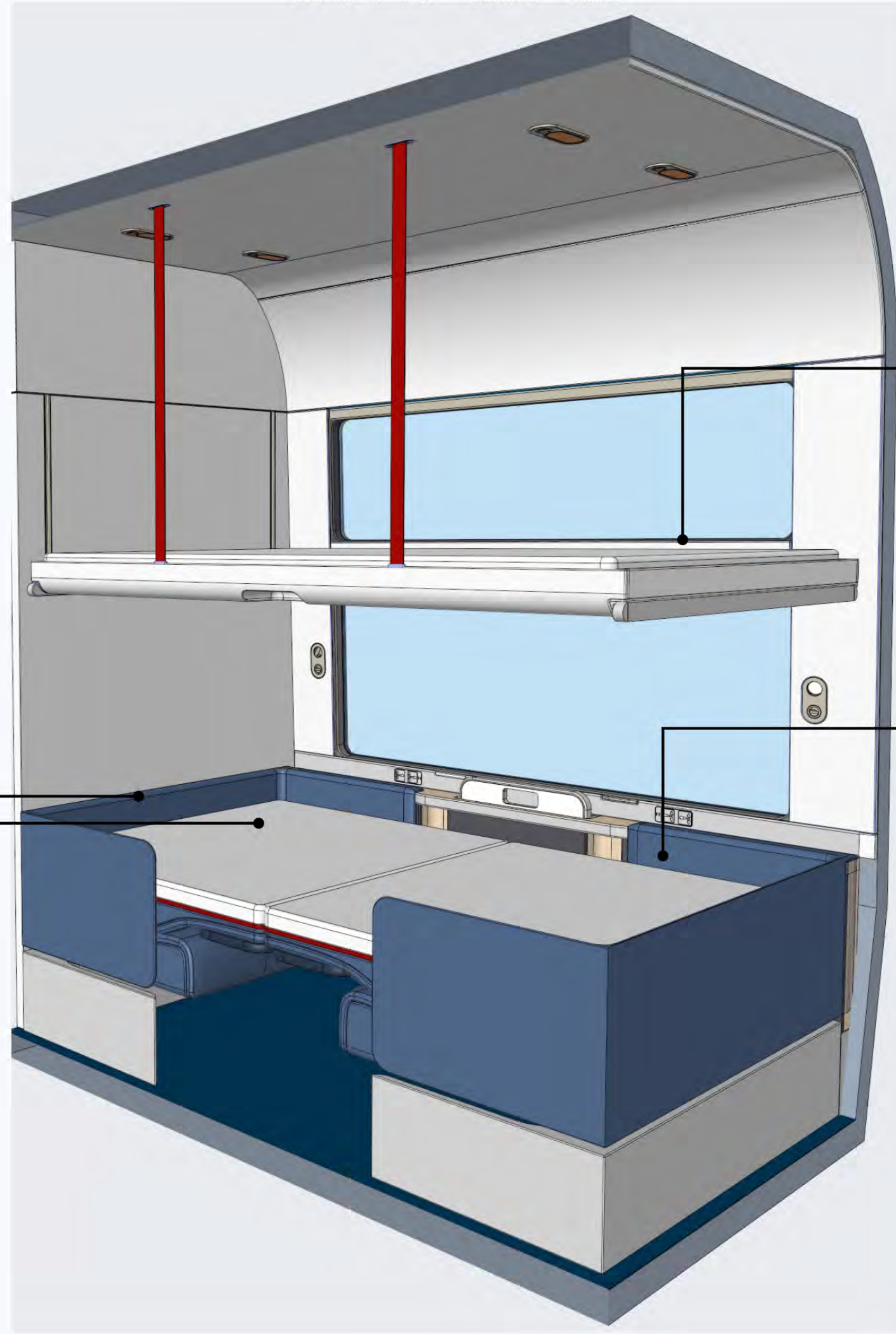

Head Board

The armrest and seat side pad should continue and connect to form a thin soft headboard around the back of the seat when the bed for the lower berth is down.

Lower Berth

Conversion of seats to bed should result in an entirely flat bed surface. The mattress surface should be integral to the seat. A single seam between the bed surface is acceptable with a single thin topper to finish the bed surface.

Bunk Dimensions

Should be maximized to the available width with a minimum width 44" x minimum length of 77".

Lower Berth Dimensions

Should be maximized to the available width with a minimum width 48" x minimum length 77".

Club Bedroom | Upper Bunk Access



Minimum Clear Way

A free clear channel should be provided. Key dimensions and access to the upper bunk will be subject to mockup testing and Amtrak approval.

Handrails and Grabs

Suitable handholds shall be provided to assist people transitioning to the bunk. These should be positioned on both sides of the bunk. Additional handholds may be required to assist people climbing down safely from the bunk, positioned closer to the door of the room.

Steps

At least three integrated steps should be built into the area beside the seat to allow people to safely transition to and from the upper bunk. Step width should be at least 15" wide. Step surfaces shall be free from trip hazards and have an anti-slip finish to the tread surfaces. Steps shall be designed in such a way that the seat cushions, armrests, any soft furnishings are protected and clear of tread surfaces. Design of the steps should discourage people from using the sink surfaces as steps. Step design and access to upper bunk will be subject to mockup testing and the approval of Amtrak.

Club Bedroom | Lighting

Club Bedroom | Lighting



Lobby Lights

Panel lighting provides master ceiling light to the lobby and vanity area.



Under Seat Light

Under seat light should be indirect and spill light out across the floor.

*See lighting spec for detailed definition

Club Bedroom | Lighting

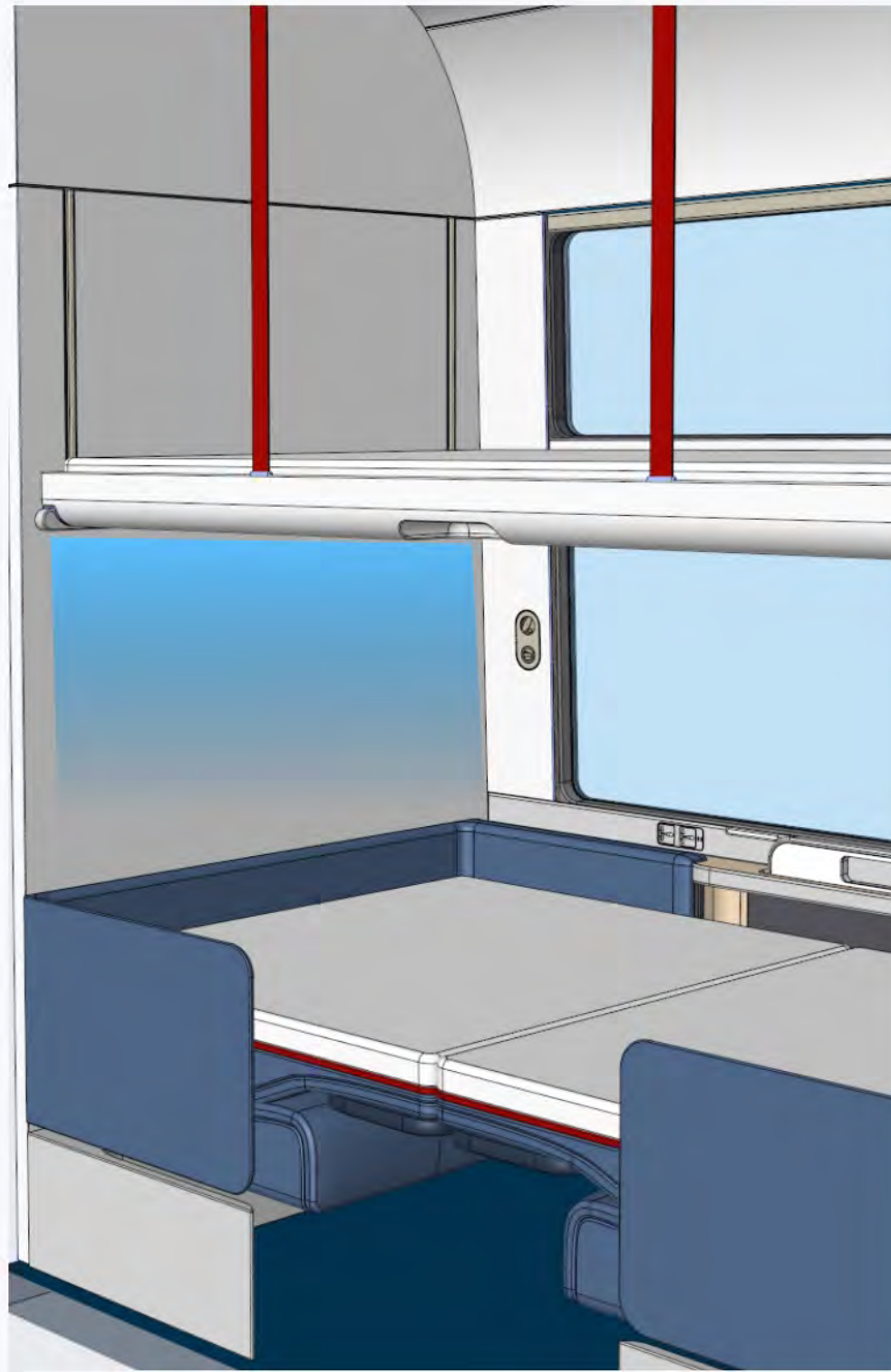

Back Wall Wash Light

Bunk support runner washes indirect light down the end walls on both sides of the room.



Back Wall Wash Light

Bunk support runner washes indirect light up across the end walls on both sides of the room.



Step Lights

Indirect light provides wash light over each of the steps.

*See lighting spec for detailed definition

Club Bedroom | Lighting

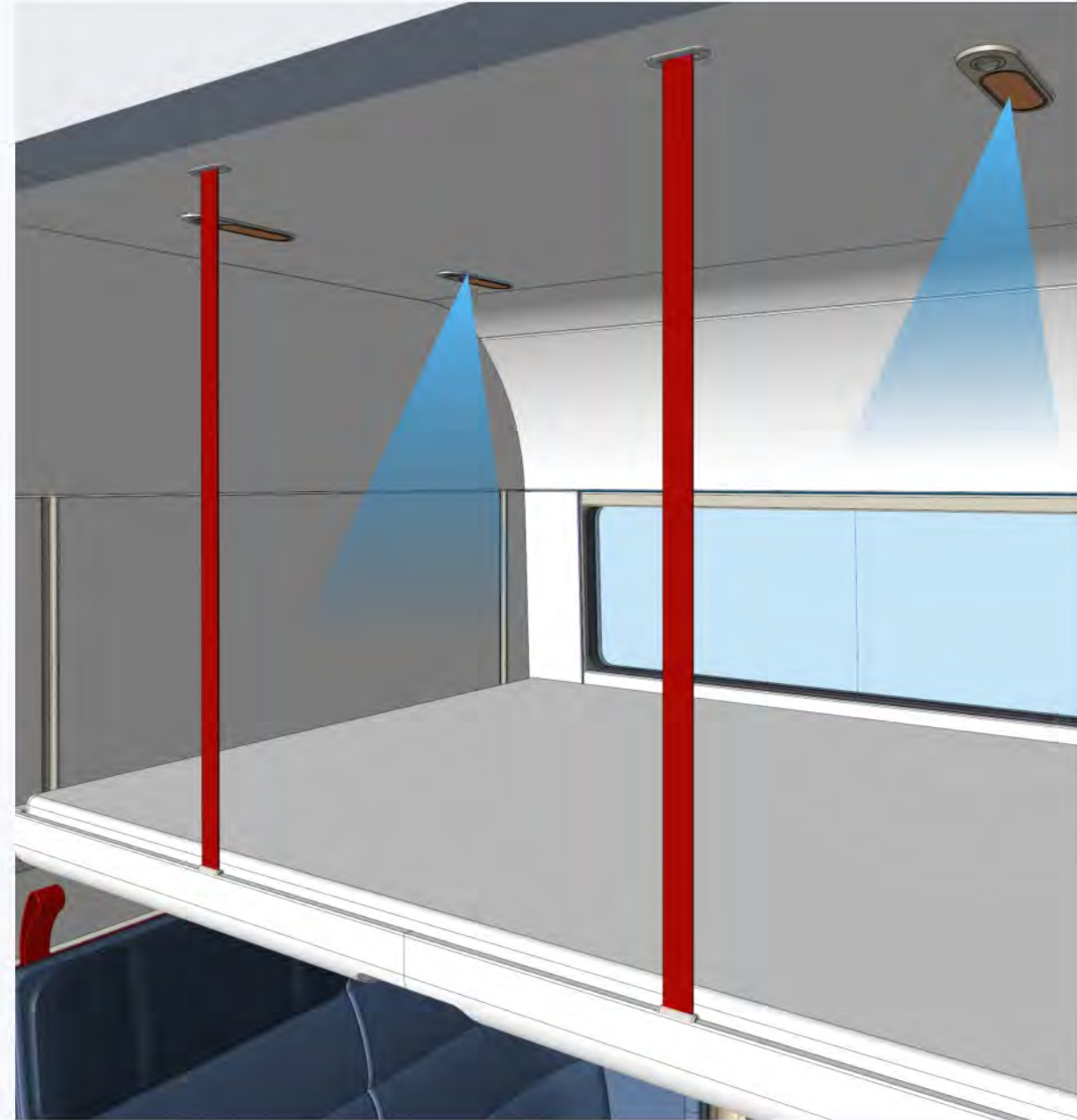

Upper Reading Lights

Reading lights should be provided, embedded in the ceiling above the bunk. These should be mini panel lights. 2 lights in total located at each end of the bed. Light switches should be located next to the reading light.

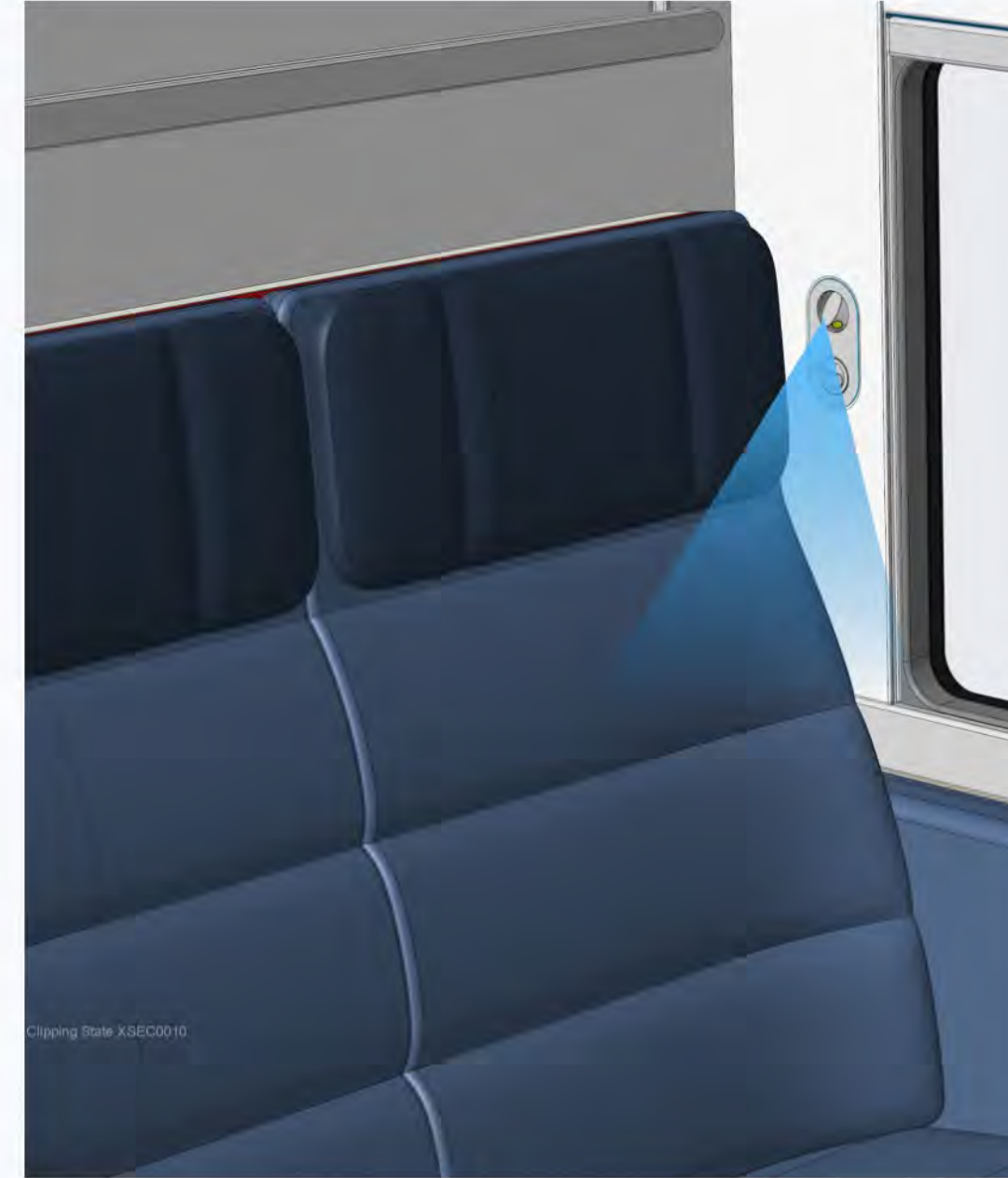

Lower Reading Lights

Reading lights should be provided at each seated location. People should be able to adjust the direction, position the light over their lap to be able to read a book at night. Switches should be located near or on the light.

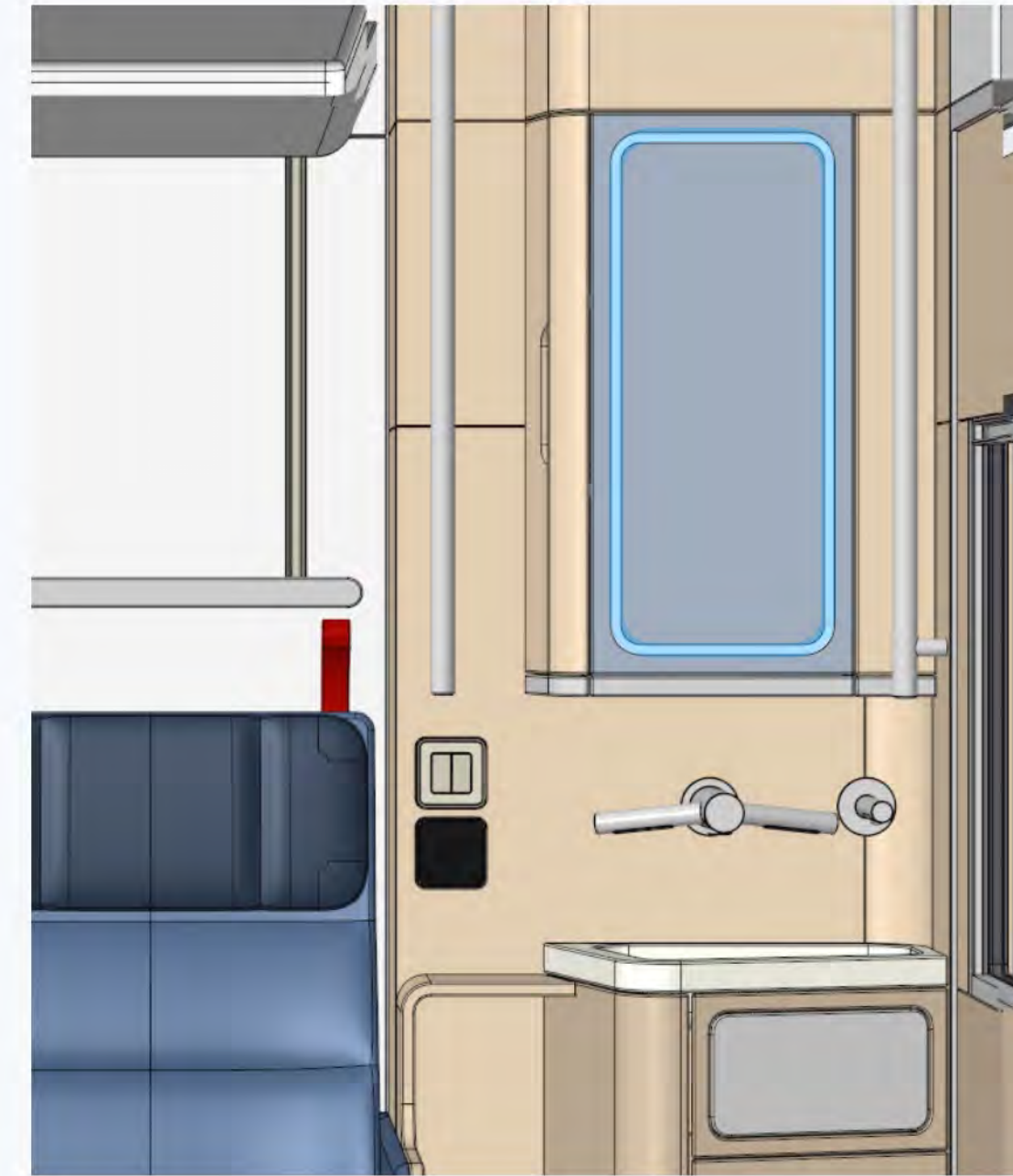

Mirror Light

The vanity mirror is illuminated with a back light or similar.

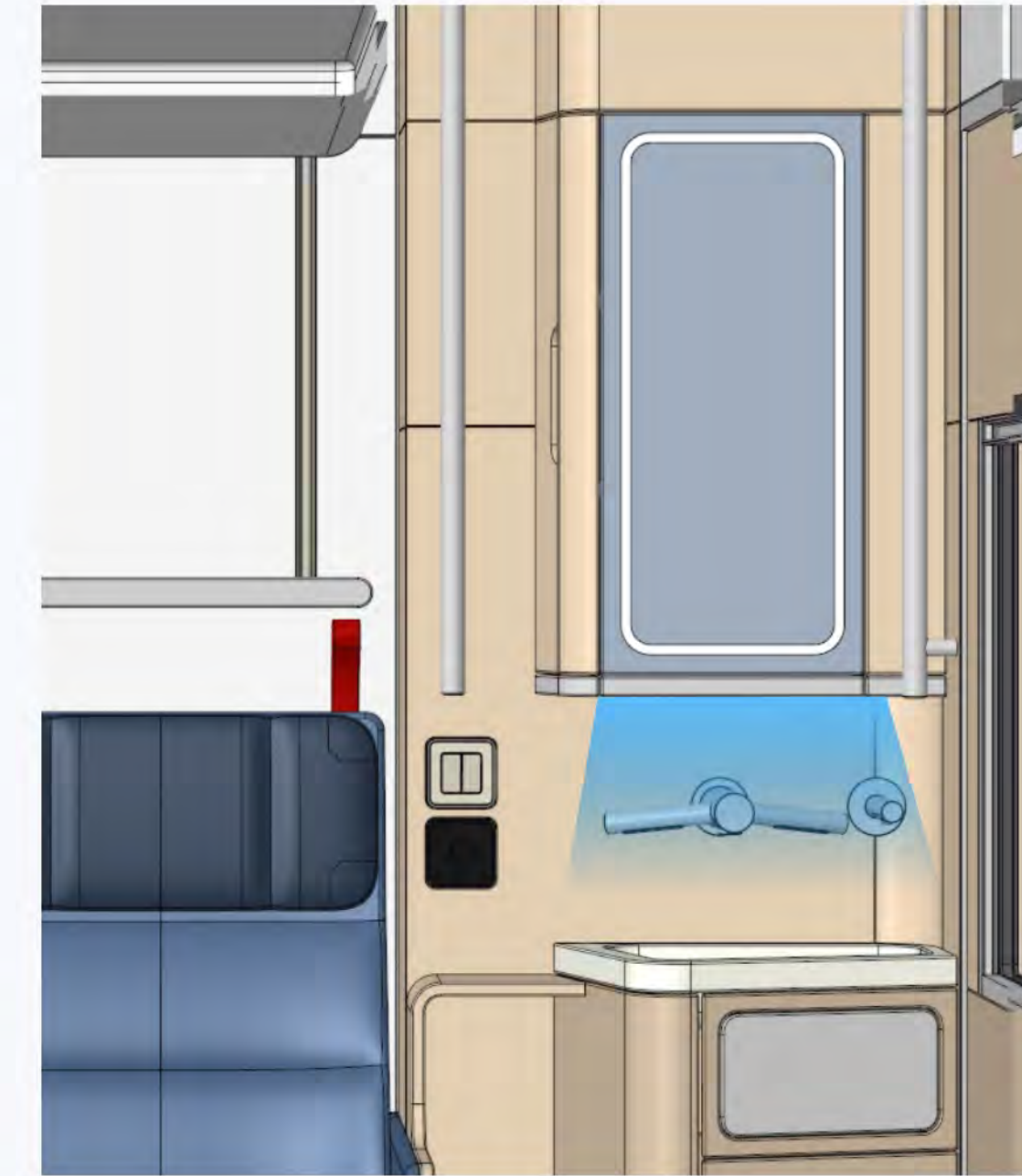

Vanity Light

The vanity surface is illuminated with an indirect lighting.

*See lighting spec for detailed definition

Club Bedroom | Toilet & Shower

Club Bedroom | Bathroom Features



LH Side

Toilet

The toilet is covered by a lid that covers the toilet seat and also acts as a shower seat.

While the bathroom is being used as a shower the lid should disguise the toilet seat forming a bench across the width of the room. The form of the toilet is undercut at the bottom to maximize standing space in the shower area. The design of the toilet, access and lid design will be subject to testing and ergonomic review during mockup stages and subject to the approval of Amtrak.

A separate more standard toilet seat and toilet lid may be required with the shower seat acting as an additional layer with the sole purpose of hiding the toilet and providing a shower seat.

Toilet seat, seat lid and shower seat should all have soft close mechanisms.

Toilet Flush

A two button push flush is located on the back wall providing standard and eco flush.

Toilet Paper Storage

The toilet paper should be stored in the wall of the bathroom with a waterproof cover to protect it from getting wet with shower water.



RH Side

Club Bedroom | Bathroom Features



LH Side

Towel Storage

A shelf on the back wall of the bathroom of a suitable size to store a minimum of 4 Amtrak bath towels. The shelf and towels are to be placed high and out of the direction of any shower water when the shower is in use.

Dispensing Bottles

3 refillable Amtrak bottles dispensing shampoo, conditioner and body lotion. Bottles should be fixed to the wall and easily refilled or replaced by Amtrak staff.

Grab Handles

Suitable grab rails should be positioned to aid people while standing in the bathroom for both showering and for use of the toilet. Locations and sizes will be subject to mockup testing and Amtrak approval.



RH Side

Club Bedroom | Bathroom Features

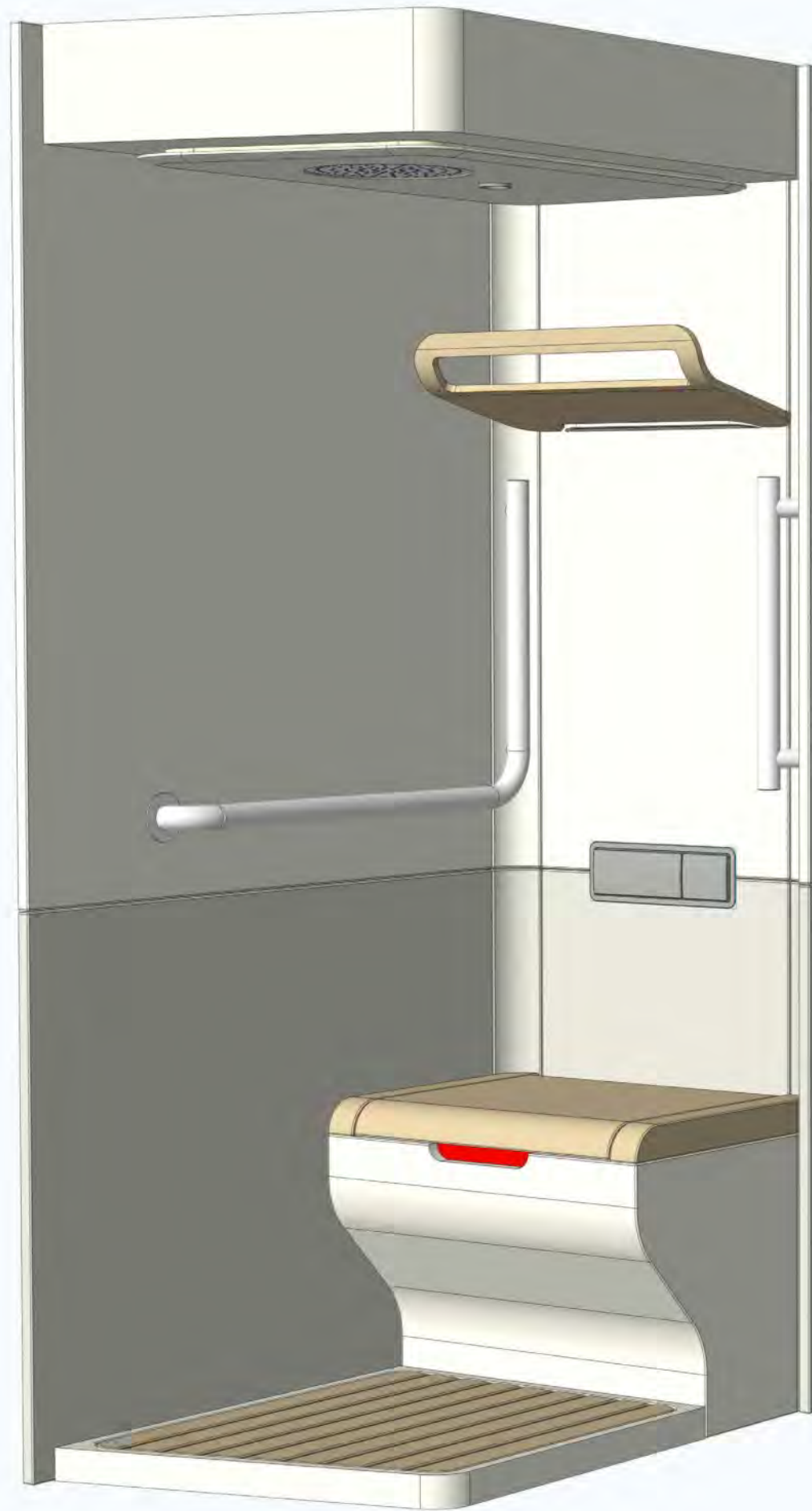

LH Side

Rain Shower

A rain shower in the ceiling provides a shower above head height. Rain shower should be seamlessly integrated into the ceiling in order to maximize head room in the bathroom.

Hand Shower

A second hand shower is located with a slimline design handset. A hose clip should be included to prevent the hose from rattling while the train is in transit.

Shower Control

Shower controls are located on the bathroom wall close to the door. The shower control should prevent any accidental activation when using the toilet.

Drainage

The toilet floor has a built in shower tray with a raised lip. A slatted platform finishes flush with the top of the tray to allow the shower water to drain out underneath and prevent the floor remaining wet after use as a shower. The shower tray should be designed to prevent water from escaping into the main area of the room.



RH Side

Club Bedroom | Bathroom Lighting

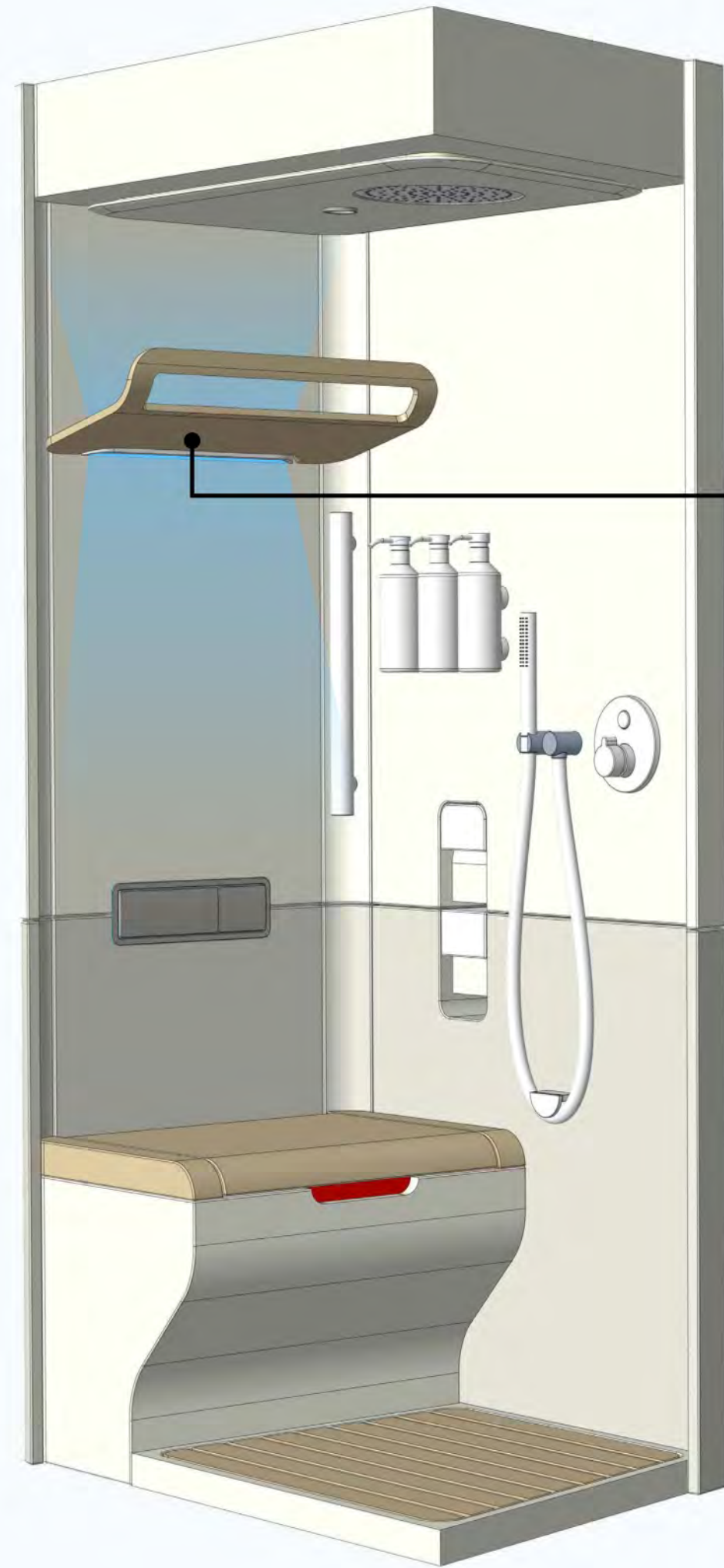

LH Side

Back Wall Wash Light

Shelf runner washes indirect light upwards and underneath the towel shelf.

LED light panel spot

Small circular LED light panels act as spot lights - frame to be color matched.



RH Side

- Coach Areas
- Sleeper Bedrooms**
- Food & Beverage
- Toilets & Showers
- Common Use Areas

07 | Accessible Bedroom

Accessible Bedroom | General

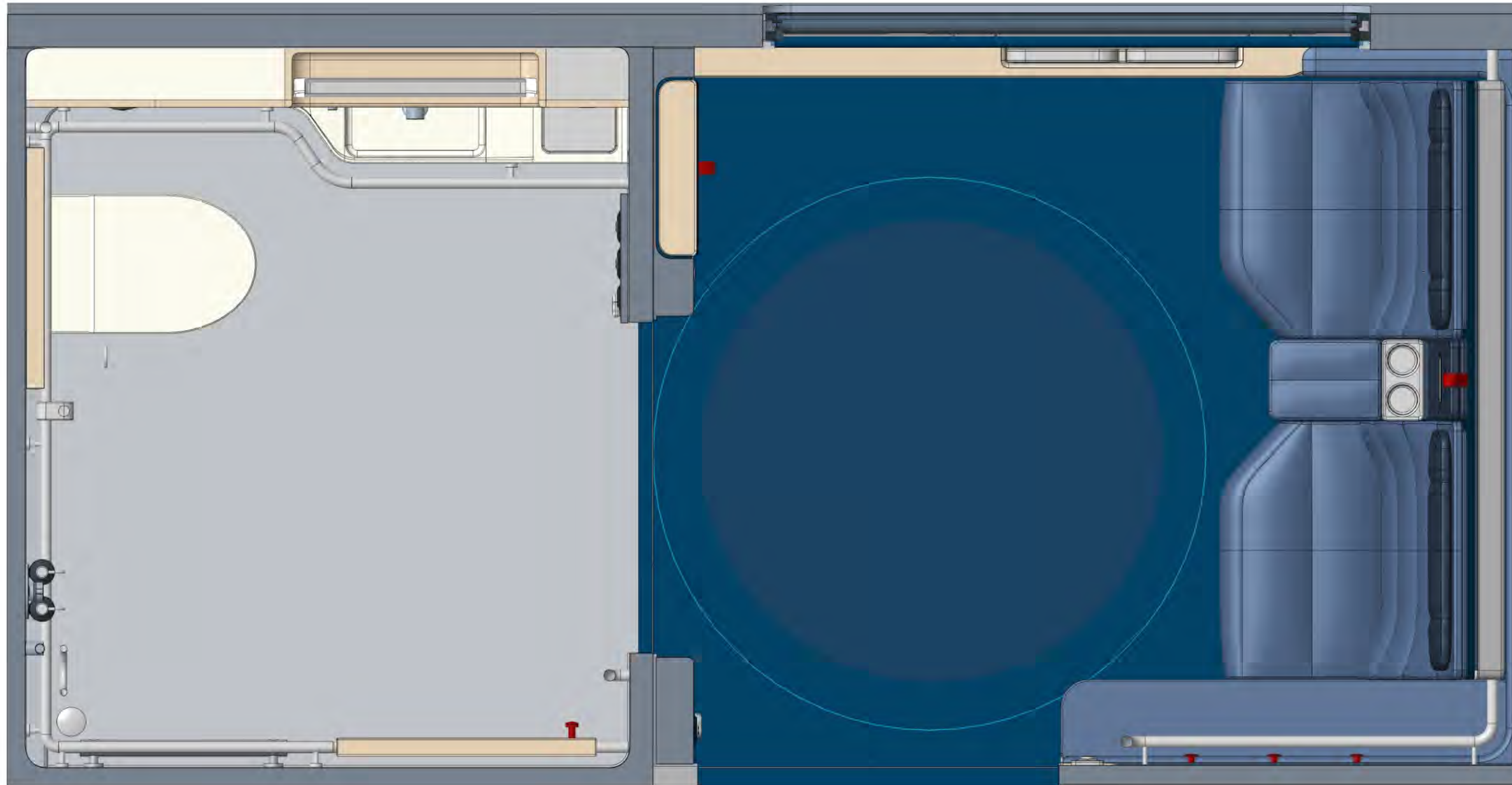

Accessible Bedroom

The Accessible Bedroom is a fully accessible room for three. The room has a double lower berth and a single upper bunk.

The accessible space is based on the RVACC recommendations to accommodate larger mobility devices. The ability to turn around in the room is facilitated by a clear 60" turning circle.

The room has an ensuite bathroom that is also fully accessible with a lockable door separating it from the living space.

Accessible Bedroom | General

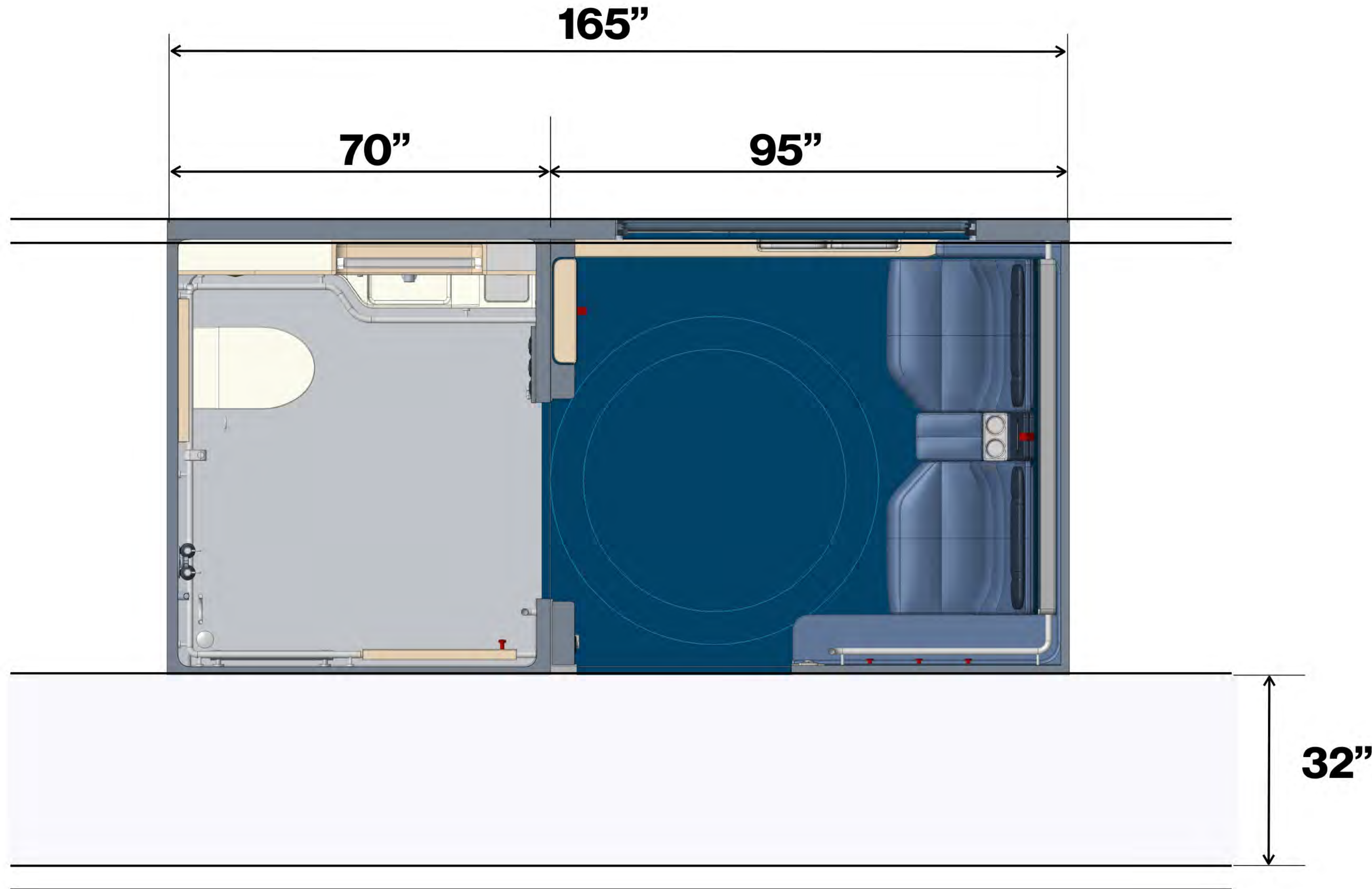

Accessible Bedroom

The Accessible Bedroom should be a maximum of 165" long and designed for a 32" side aisle.

Accessible Bedroom | Accessibility

Accessible Bedroom | Accessibility

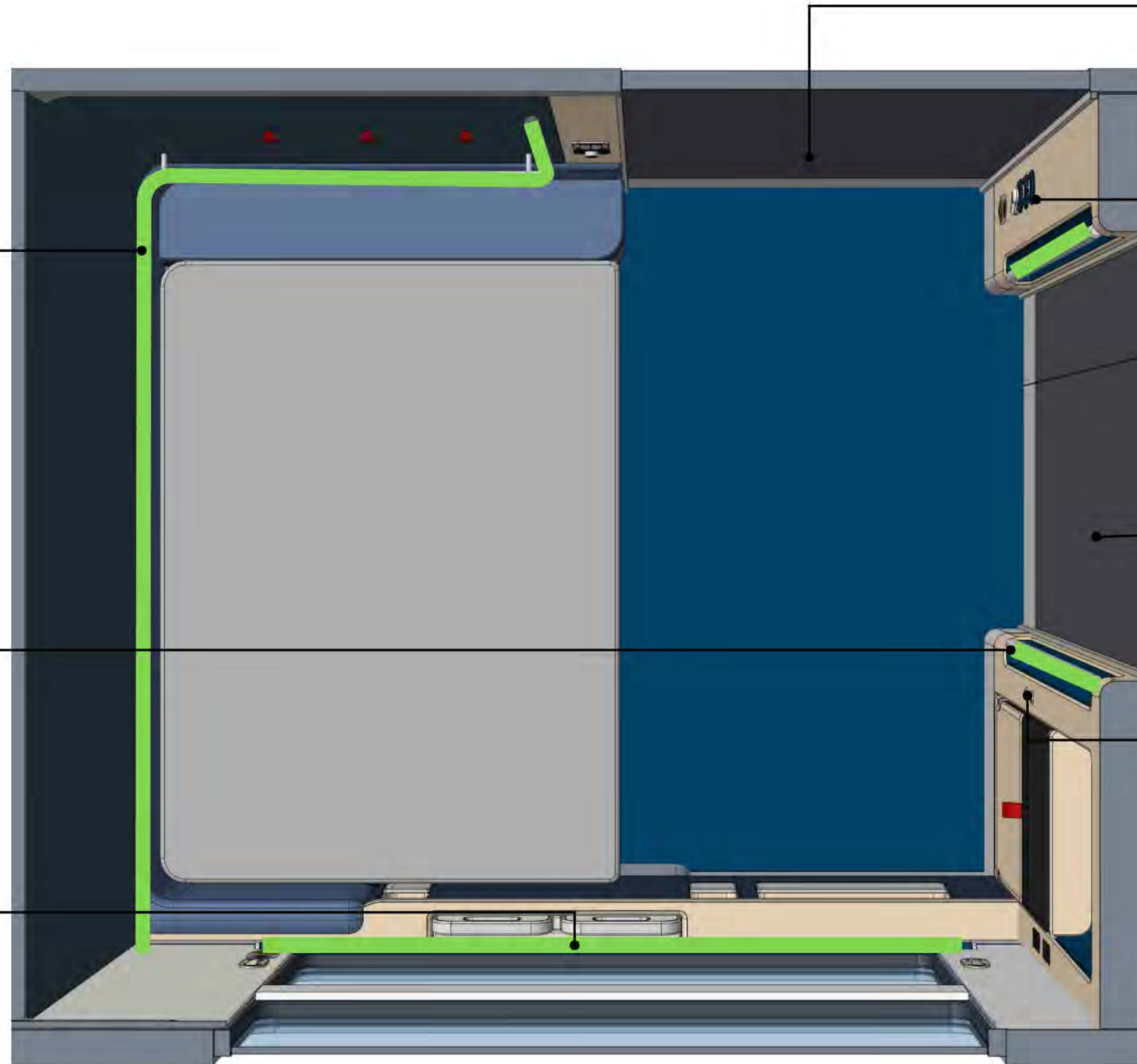

Horizontal Handrail

ADA compliant horizontal handrails positioned adjacent to the aisle side seat to assist transfer into the seat and bed. The handrail should be positioned to maximize the space between the bed and the bottom of the handrail.

Vertical Handrail

ADA compliant vertical handrails positioned either side of the bathroom door to aid transit around the room and into the bathroom.

Horizontal Handrail

ADA compliant horizontal handrails positioned adjacent to the window side seat and accessible space. The handrail should be a minimum compliant distance (33") above the finished floor to reduce impact on the window views. The handrail should not impede the use of the table and cupholders positioned on the sidewall.

39" Room Door

Access to the room will be subject to review and mockup user testing. Room doors should be an automatic sliding door.

Room Door controls

The controls for the room door must be ADA compliant in position, size and configuration. The buttons should be easy and intuitive to use. An accessible manual lock should be included with an indicator to show lock condition. The buttons should have visual and haptic feedback.

36" Bathroom Door

The Bathroom door should be an automatic sliding door. The door should be positioned to create space for a T maneuver when the door is open and the bed is deployed.

Bathroom Door Controls

The controls for the bathroom door must be ADA compliant in position, size and configuration. The buttons should be easy and intuitive to use. The buttons should have visual and haptic feedback. The controls should be positioned away from the main room controls to prevent confusion. Dimensions, position and usability will be subject to Amtrak approval.

***The position of all Accessible interaction points, turning spaces and clearances will be subject to review, mockups, and user testing**

Accessible Bedroom | Accessibility

- Vertical Handrail**
ADA compliant vertical handrails positioned on should aid bunk access.
- Horizontal Handrail**
ADA compliant horizontal handrails should be usable at the threshold of the room and assist people who wish to transfer from a wheelchair.

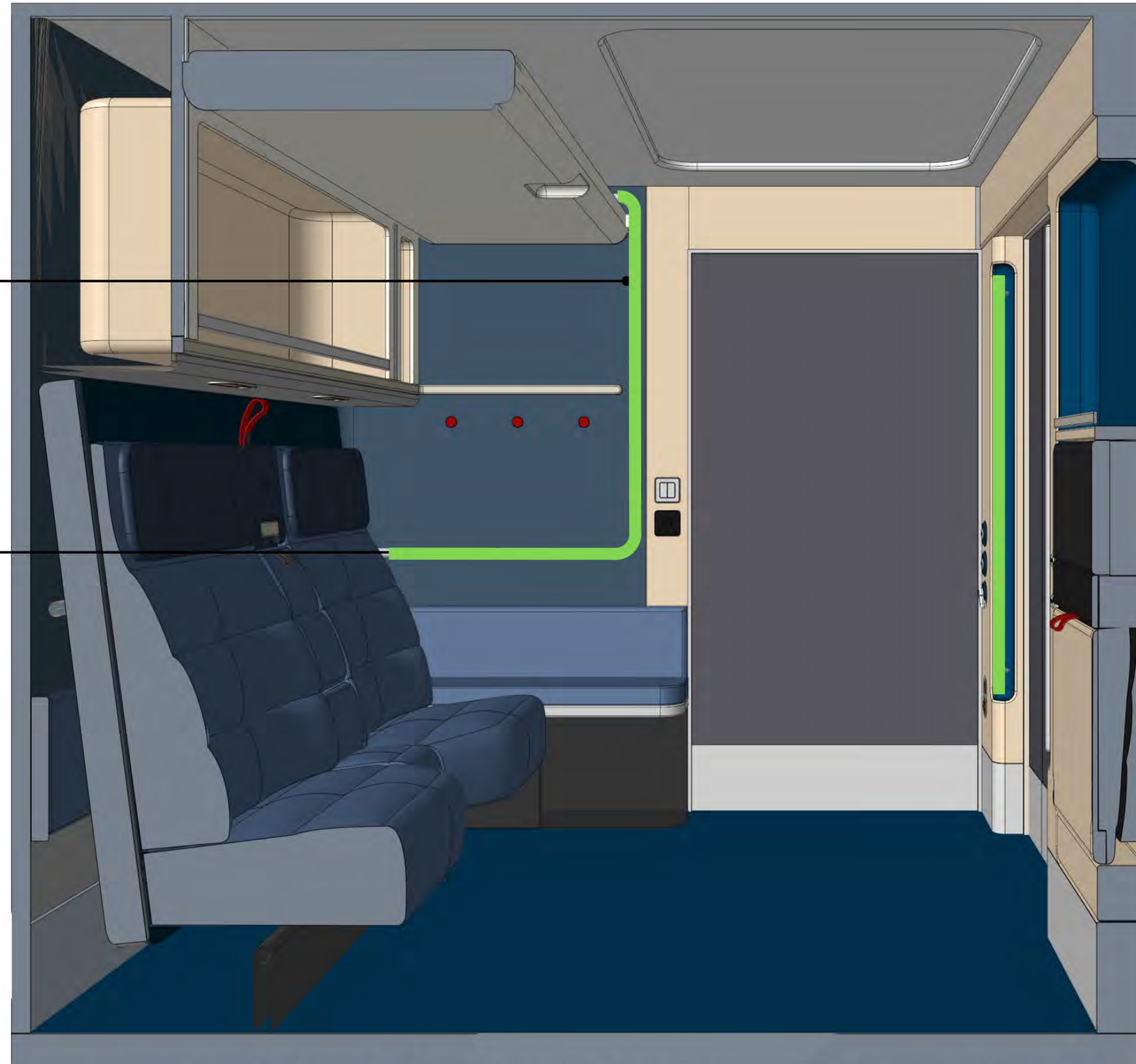

***The position of all Accessible interaction points, turning spaces and clearances will be subject to review, mockups, and user testing**

Accessible Bedroom | Accessibility

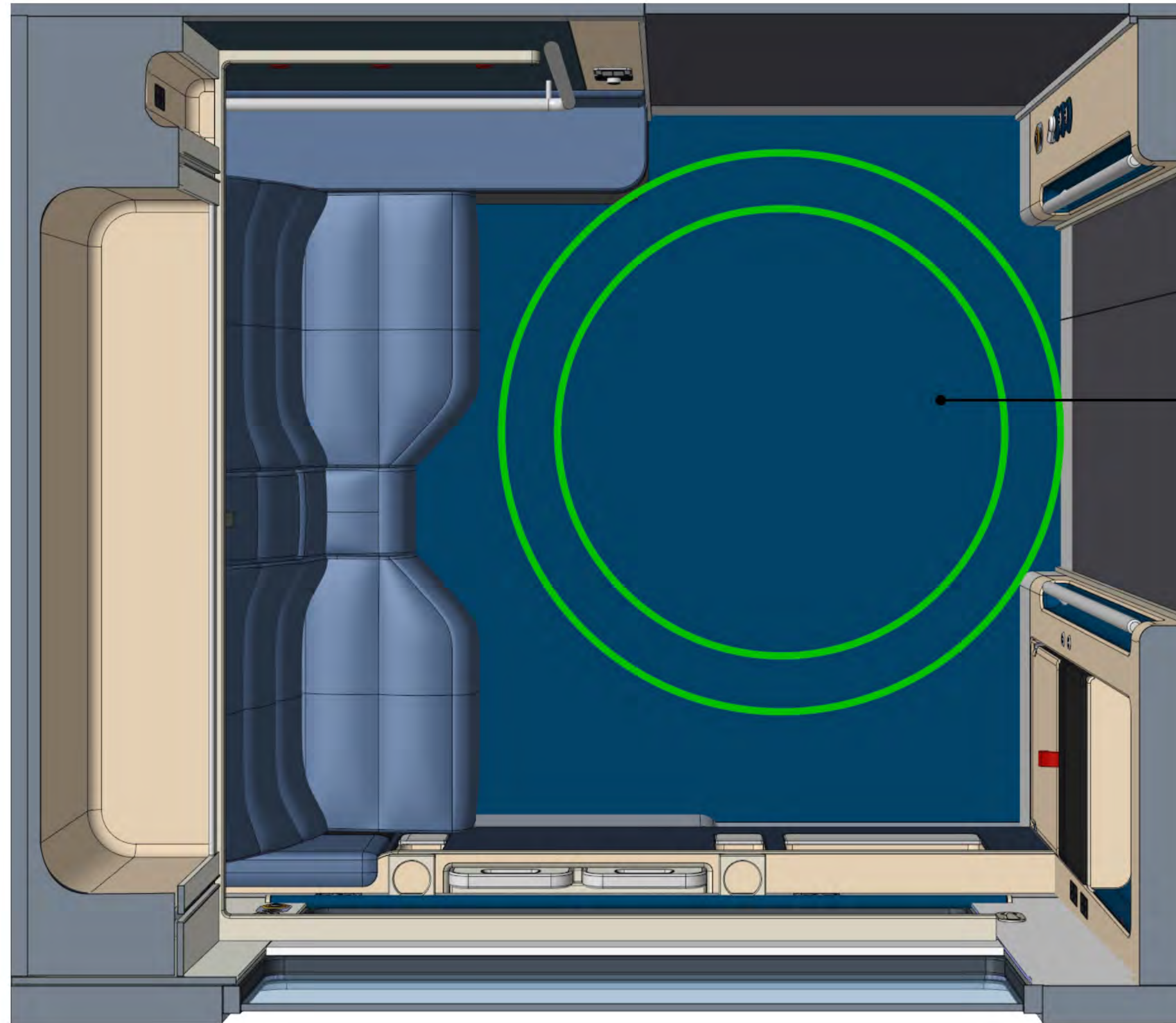

60" Turning Circle
A clear 60" turning circle should be provided inside the room when the seats are in an upright position.

***The position of all Accessible interaction points, turning spaces and clearances will be subject to review, mockups, and user testing**

Accessible Bedroom | Accessibility

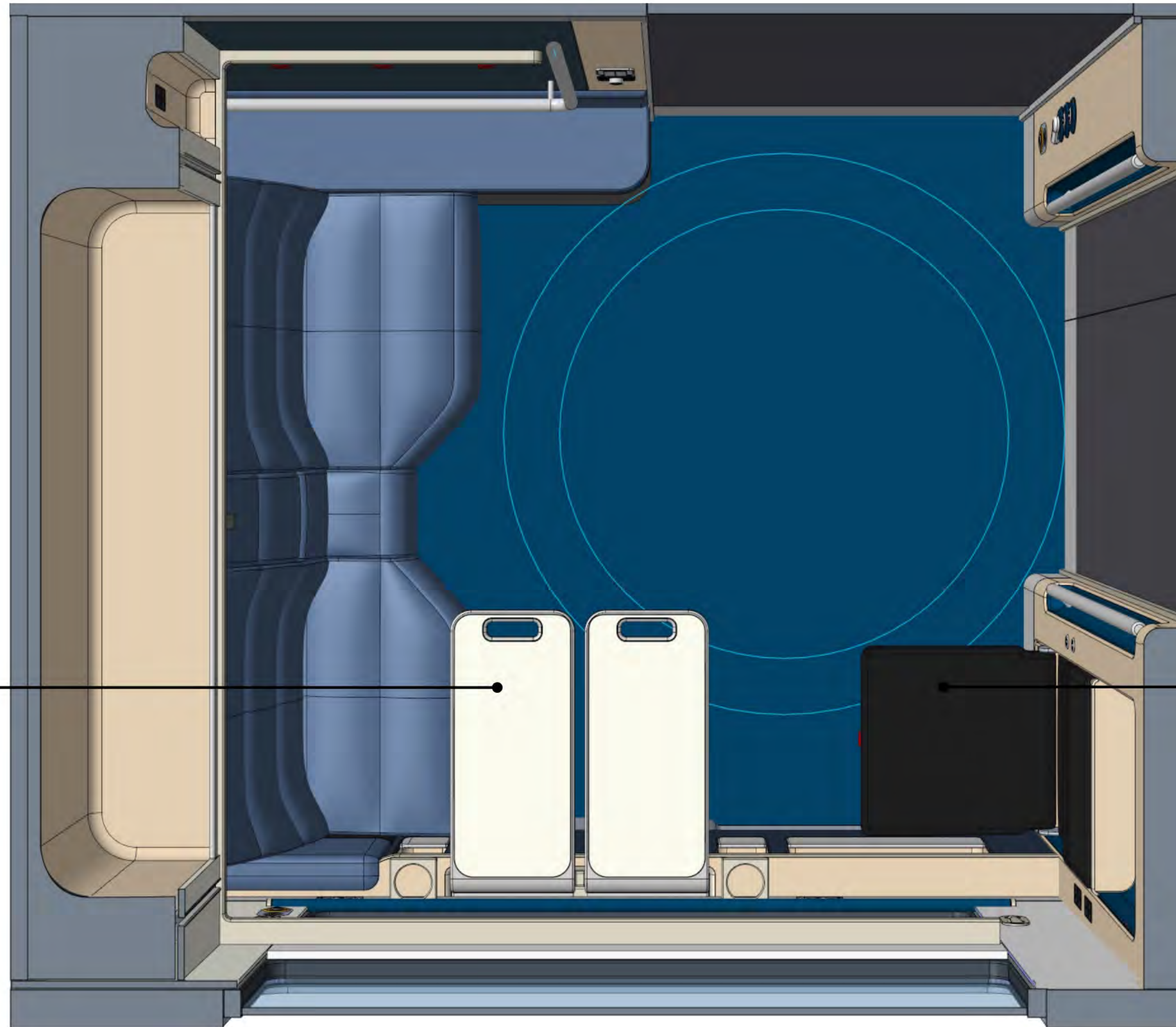

Fold Out Table Clearance

The 60" turning circle should be clear when fold out table is deployed.

Tip-up Seat Clearance

The 60" turning circle should be clear when the tip-up seat is deployed.

***The position of all Accessible interaction points, turning spaces and clearances will be subject to review, mockups, and user testing**

Accessible Bedroom | Accessibility

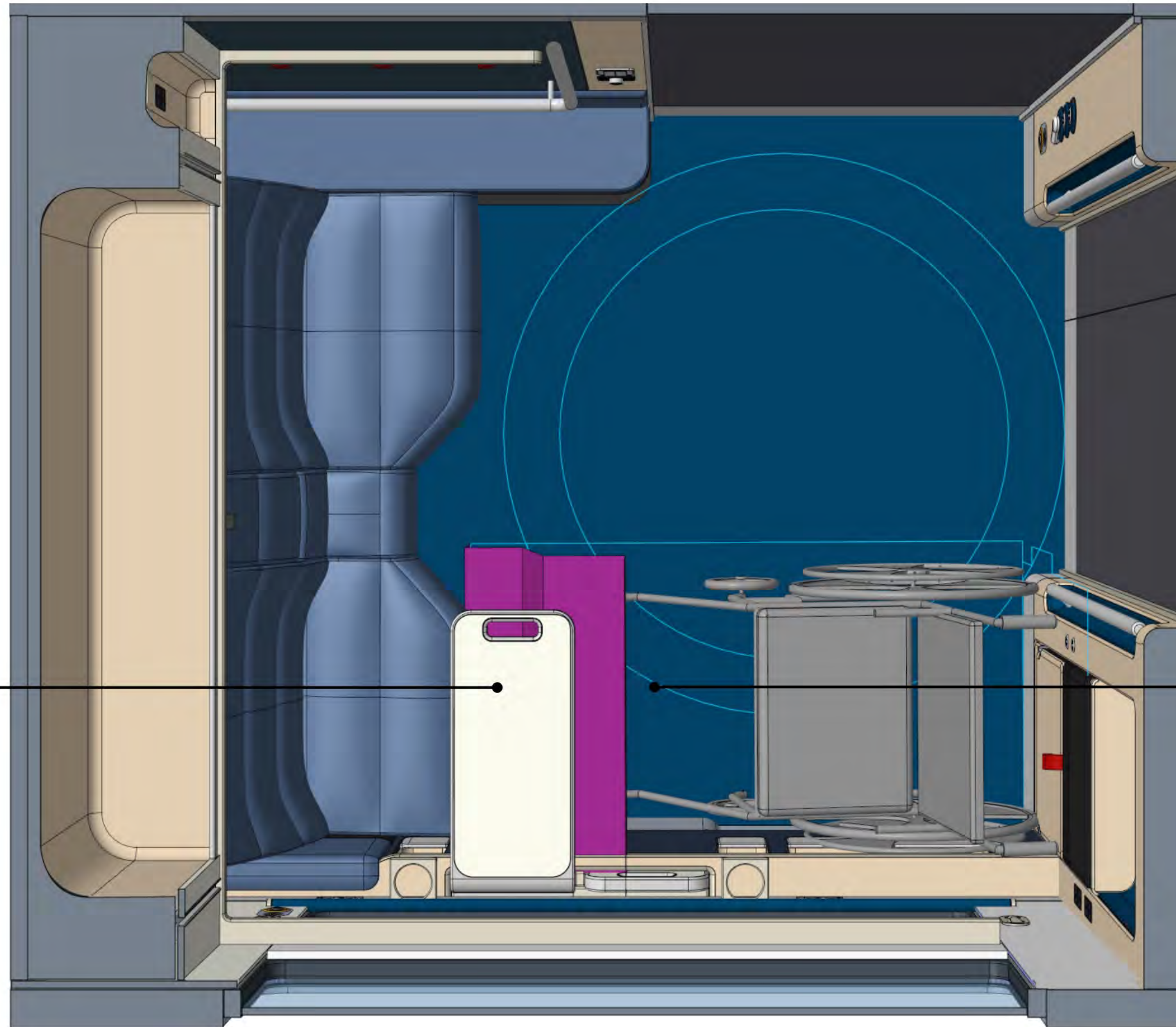

Fold Out Table

Fold out table should be positioned so when deployed it is clear of an RVAAC accessible space and an ADA accessible space.

RVAAC Accessible Space

A clear accessible space of 59" x 32" should be provided inside the room when the seats are in an upright position.

***The position of all Accessible interaction points, turning spaces and clearances will be subject to review, mockups, and user testing**

Accessible Bedroom | Accessibility

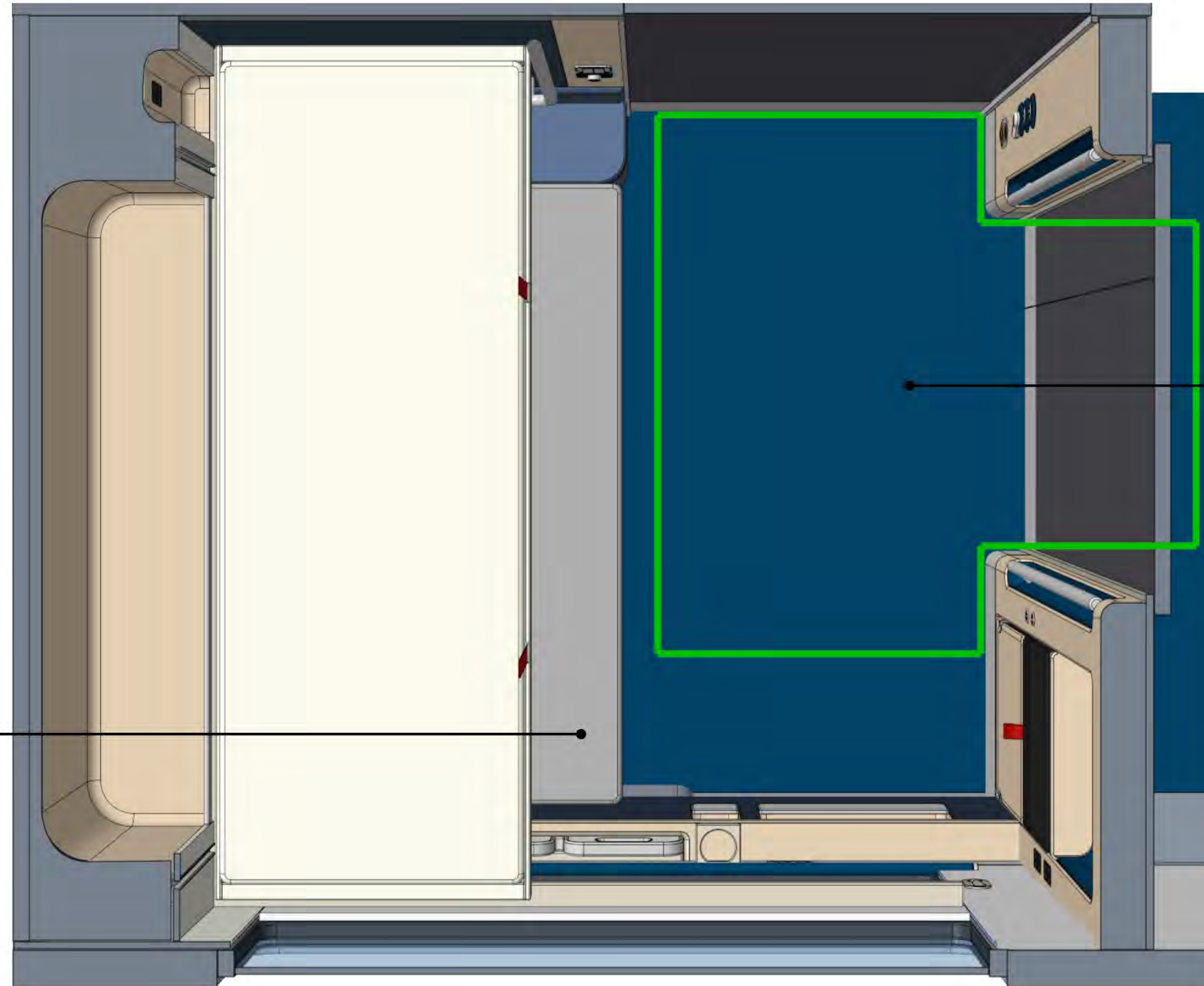

Ladder Clearance

The turning area should be clear when the bunk ladder is attached on the window side.

Turning Space

Space should be provided with a 60" turning circle or ADA approved T-manuever when the lower berth is deployed.

***The position of all Accessible interaction points, turning spaces and clearances will be subject to review, mockups, and user testing**

Accessible Bedroom | Accessibility

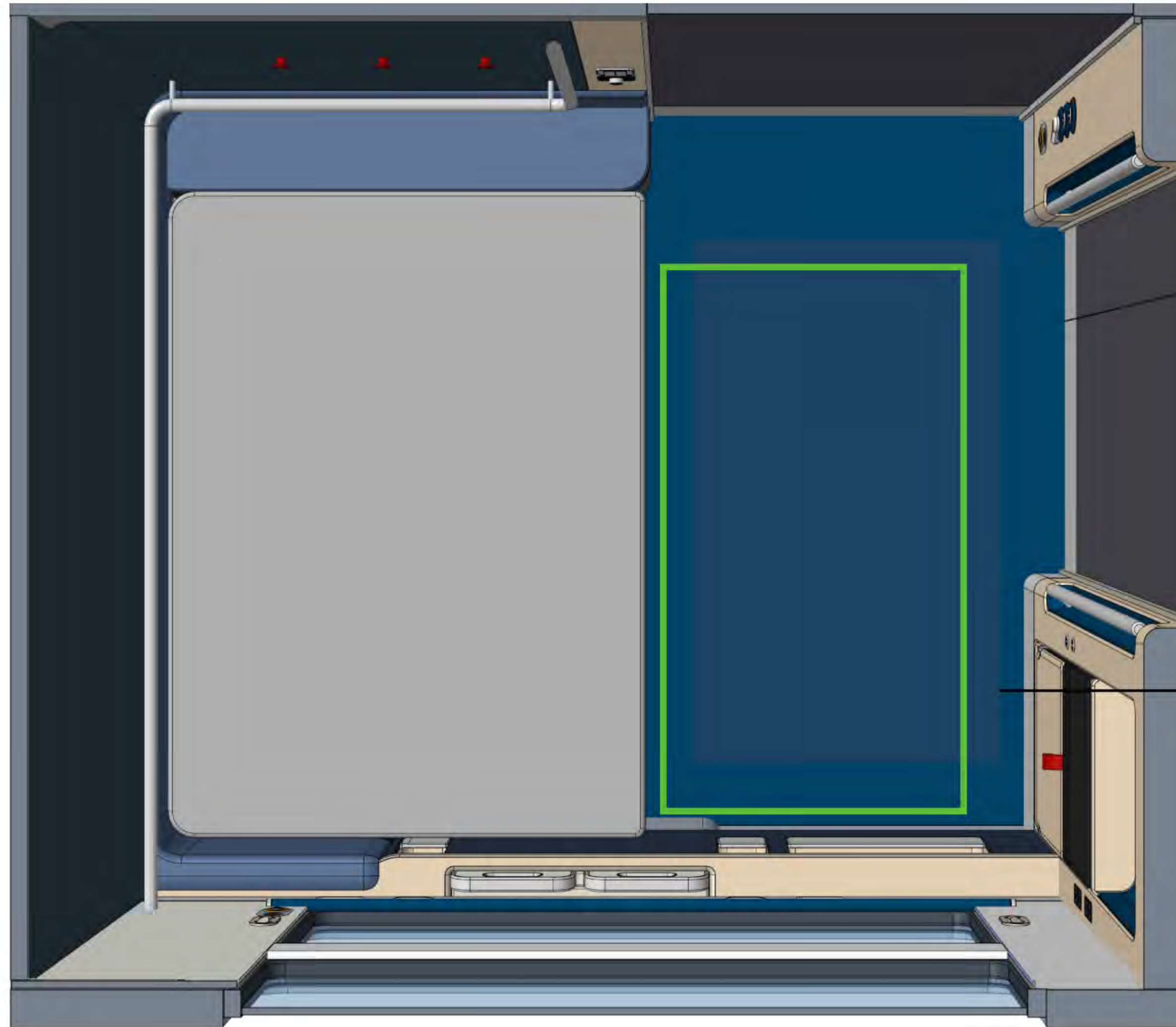

RVAAC Accessible Space
An RVAAC accessible space of 59" x 32"
should be provided for storing a
wheelchair beside the bed.

***The position of all Accessible interaction points, turning spaces and clearances will be subject to review, mockups, and user testing**

Accessible Bedroom | Features

Accessible Bedroom | Features

Seat Headrests

Seat headrest should be adjustable in height for a range of people sizes and have adjustable wings that fold outwards to adjust the width of the headrest.

Seat Shape

The seat shape should be optimized to maximize clear floor area, aid wheelchair transfer, and facilitate an accessible, self-sufficient bed deployment.

Seat Comfort

Seat cushions should be contoured to aid seat comfort.

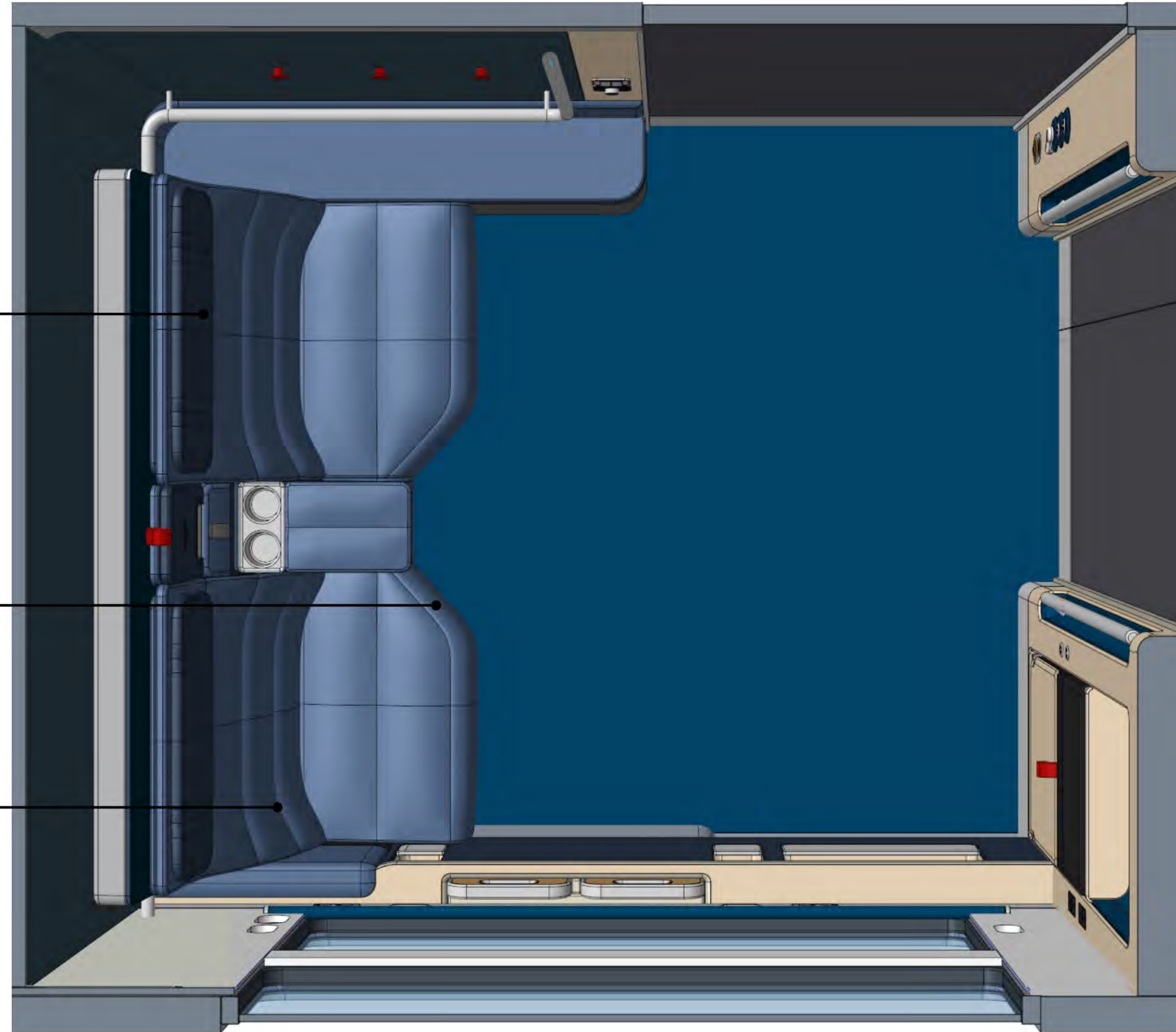

Accessible Bedroom | Features

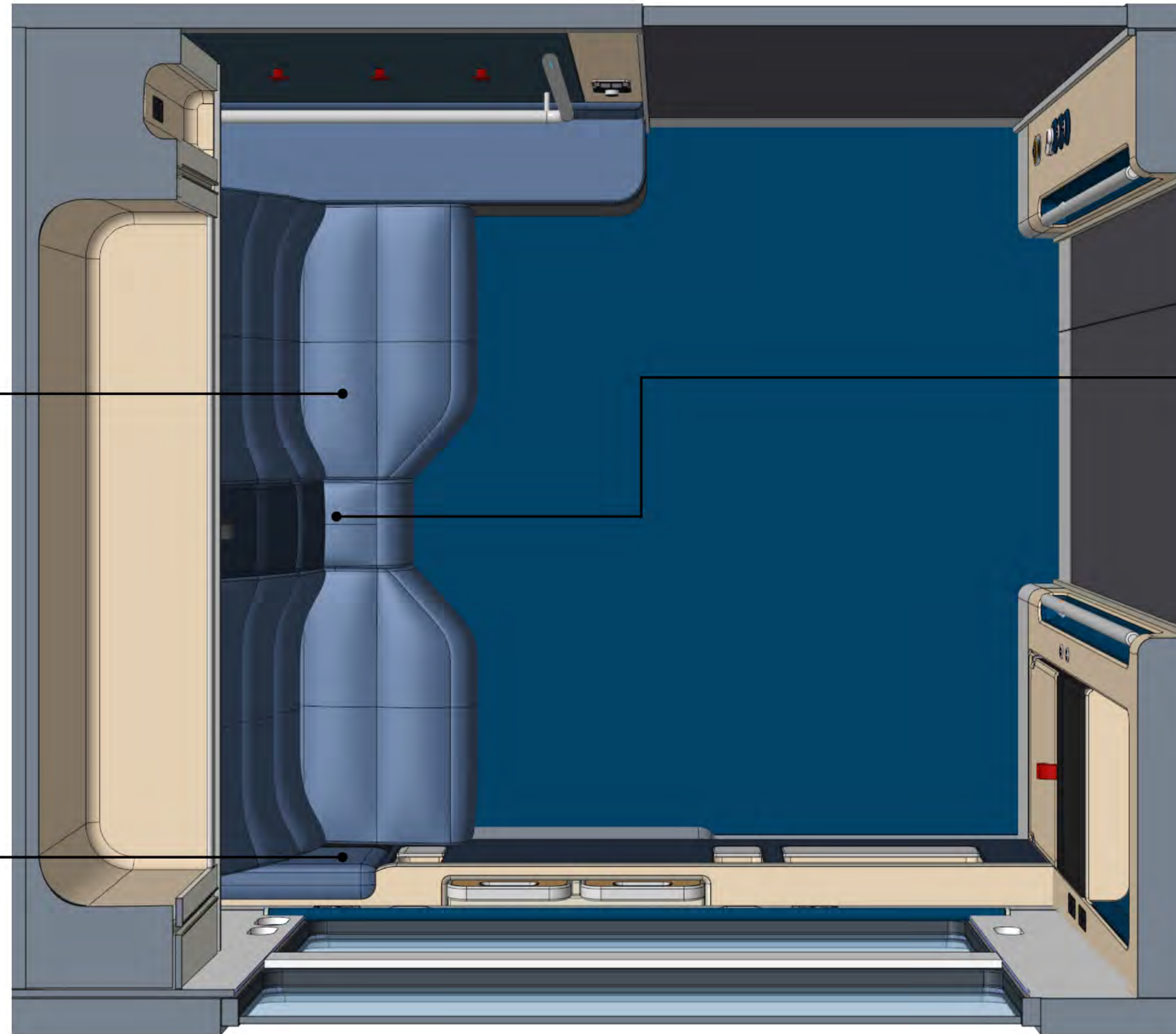

Seat Dimensions

Each seat should have a minimum width of 28" between the inside armrests and the central armrest.

Center Armrest

A full and cushioned armrest should be provided between the two seats. The armrest should have provision for two cup holders.

Armrest

A full and cushioned armrest of 3.5" should be provided on the windows side. The armrest should be of a suitable length for a seated passenger to rest their forearm on the cushioned section.

Accessible Bedroom | Features

Seat Dimensions

All seat dimensions, cushion density/shore hardness will be subject to mockup review and approval by Amtrak.

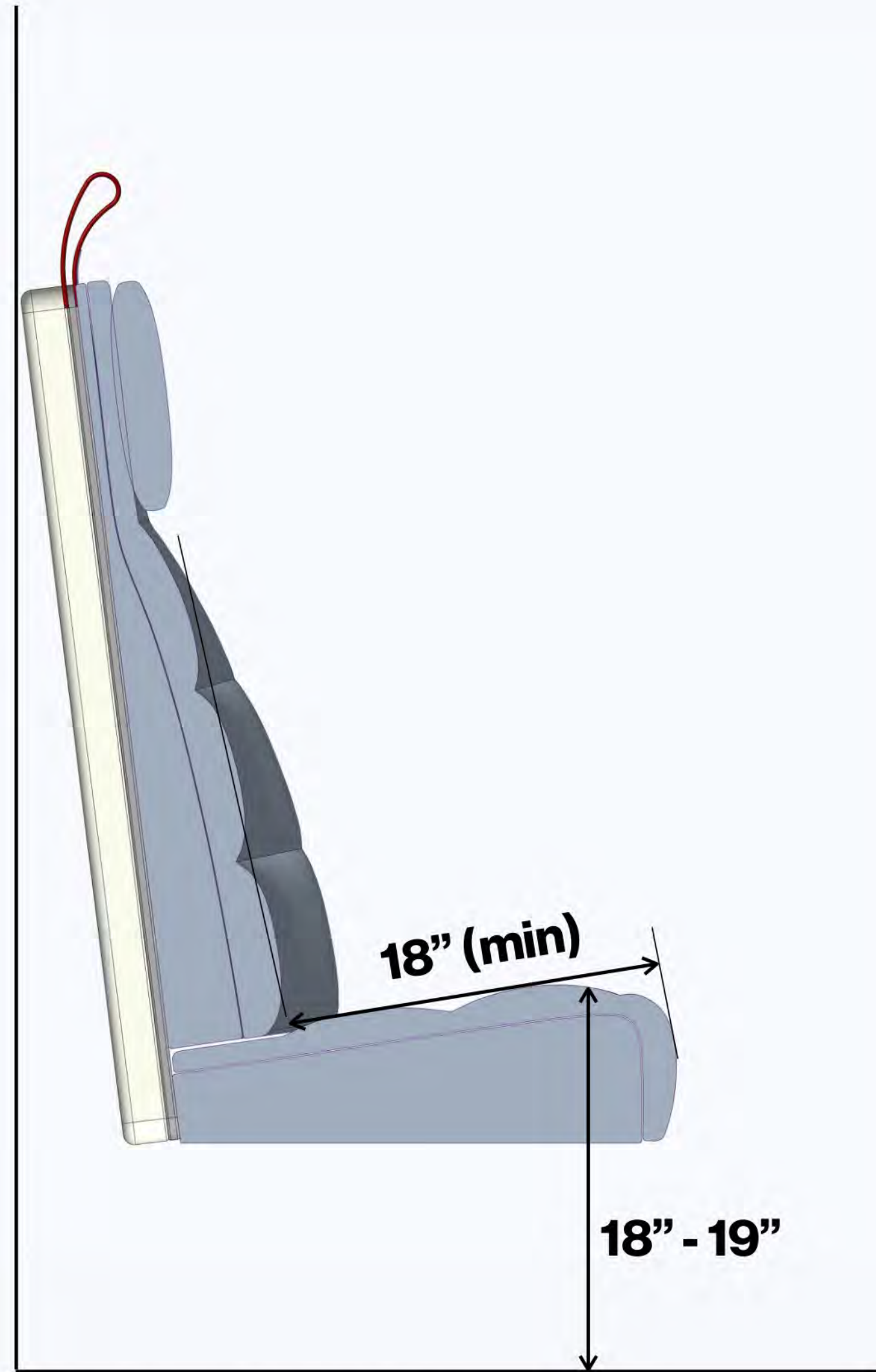

DRAWINGS NOT TO SCALE

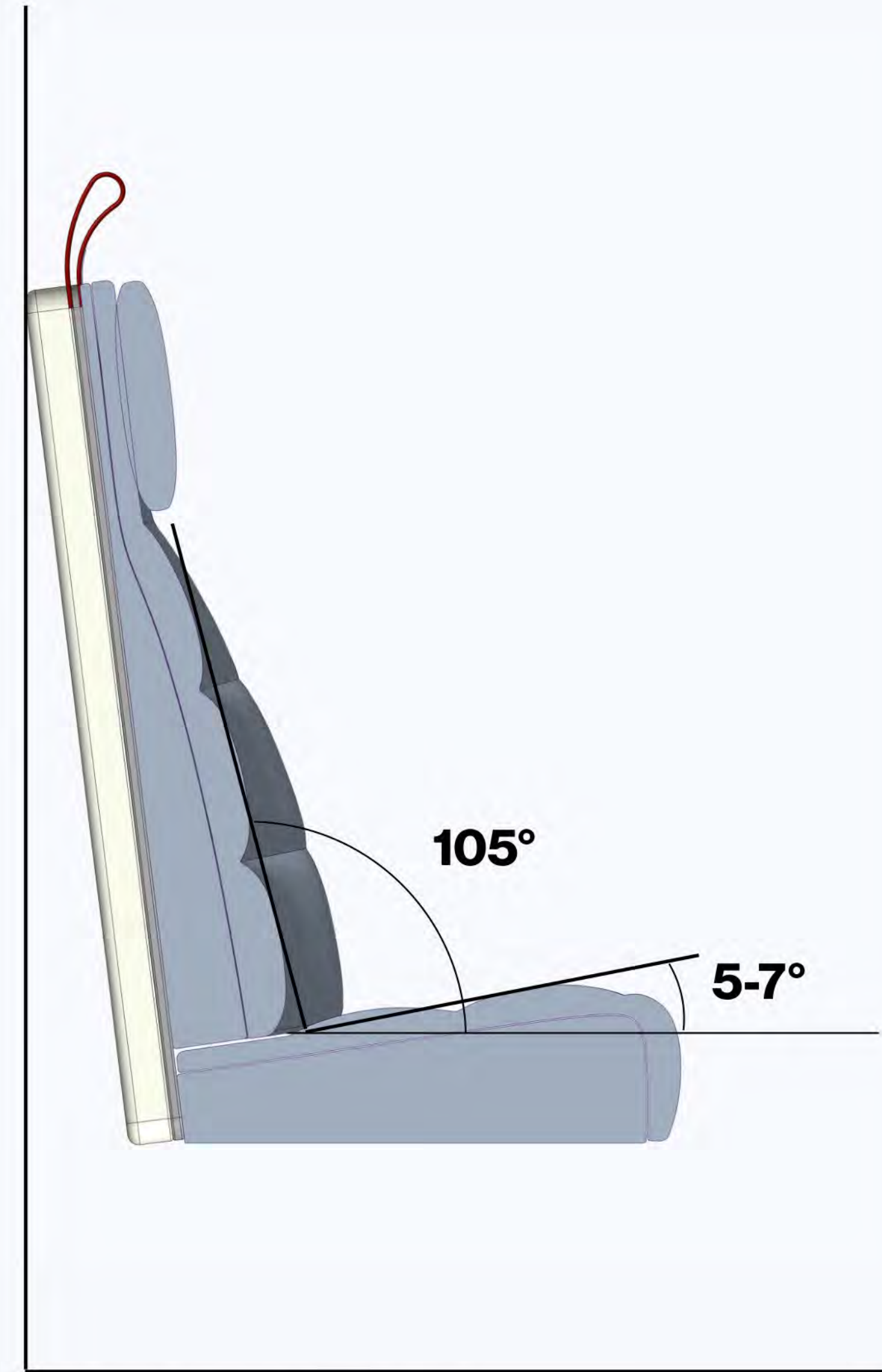

DRAWINGS NOT TO SCALE

Accessible Bedroom | Features

Fold Out Tables

Fold out table should be provide clearance for mobility devices of different sizes while also providing a good table surface for a person sat in the fold out seat.

Cup Holders

Two cupholders located so people can use and access the cupholders from a seated position and can fold away when not in use.

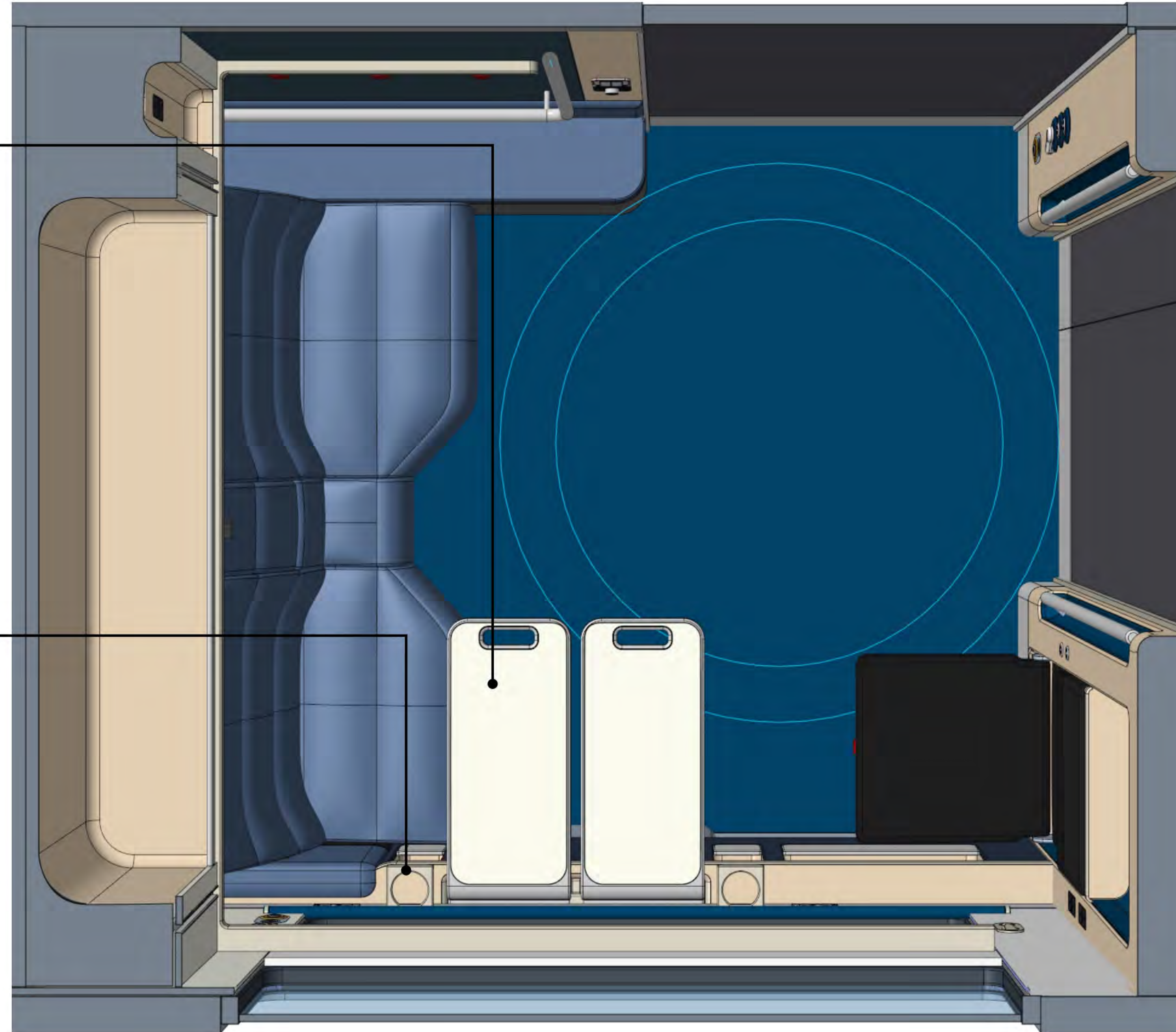

Accessible Bedroom | Features

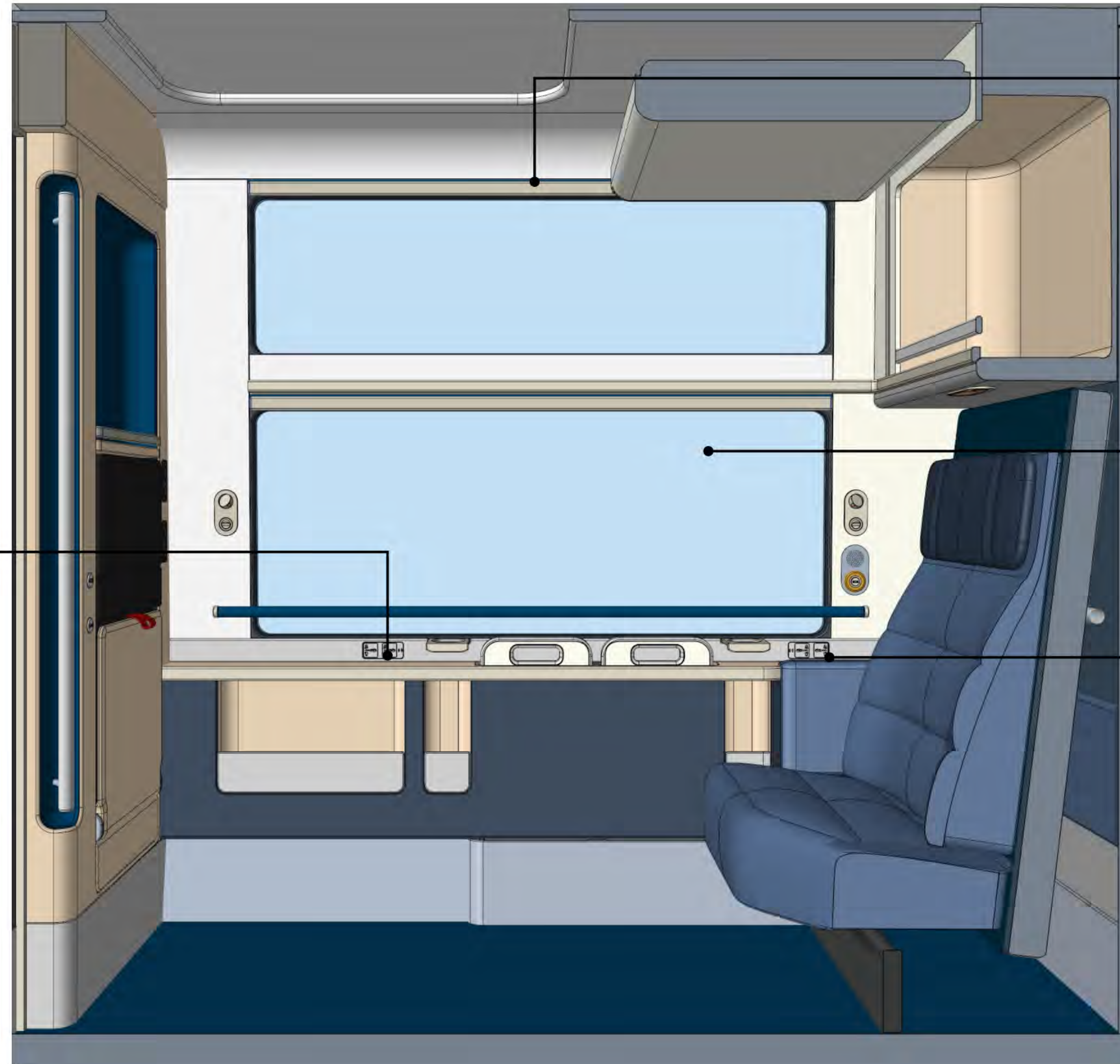

Accessible Seat Power

Two power sockets and two USB sockets should be provided near the accessible space suitable for charging an electric wheelchair. The position should comply with ADA and be clear and intuitive to use.

Blinds

A single pull-down blind system shall be provided per window, capable of delivering both daytime solar/glare control and full blackout performance.

Window and Window Mask

Window and window mask should be positioned so each seated position has clear views with the overall window size maximized.

At Seat Power

Two power sockets and two USB sockets should be provided to each seated location. The position should be above the armrest height and in easy reach of people while seated.

Accessible Bedroom | Features

Bunk Power Outlet

Two power sockets and two USB ports shall be accessible from the top bunk when the bunk is deployed.

Lower Berth Power Outlet

Two power sockets and two USB ports positioned in the lower cubby. The outlet should be ADA compliant reach when passengers are seated and accessible from the lower berth when the bed is deployed.



Accessible Bedroom | Features

Tip-up Seat

Tip up seat should fold up flush with the side wall to provide a clear and unobstructed space for wheelchairs. Spaces when folded should be durable and suitable to back a wheelchair against. When deployed the seat should reveal a soft cushioned seat back and headrest so when deployed should have similar comfort levels as the other seats in the room. The seat should be positioned to have good access to the fold out table with a minimum seat width of 21" and minimum seat pan depth of 19".

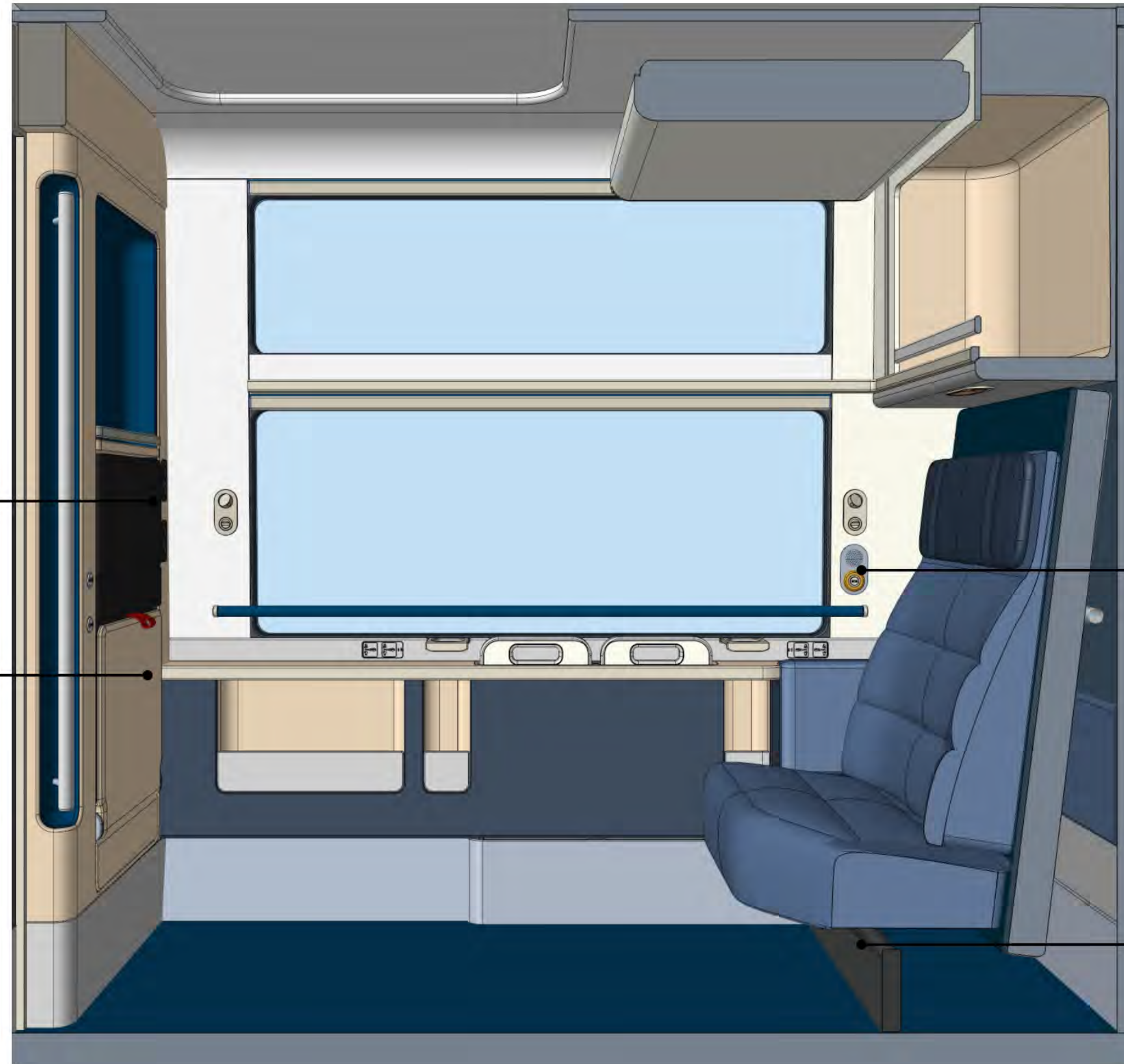

Call for Aid

Provision for call for aid by seat - locations for all call for aids are subject for review and in compliance with ADA regulations detailed in technical specification.

Under Seat Clearance

Space under the seat can be used to provide clearance for wheelchair.

Accessible Bedroom | Features



Master Light Switch

Master light switches to be positioned near the door. A second master switch should be safely accessible by a person lying in the bed. The position of light switches should be ADA compliant.

Temperature Control

Doors

Door free from rattle, smooth sliding operation.

Accessible Bedroom | Storage

Accessible Bedroom | Storage

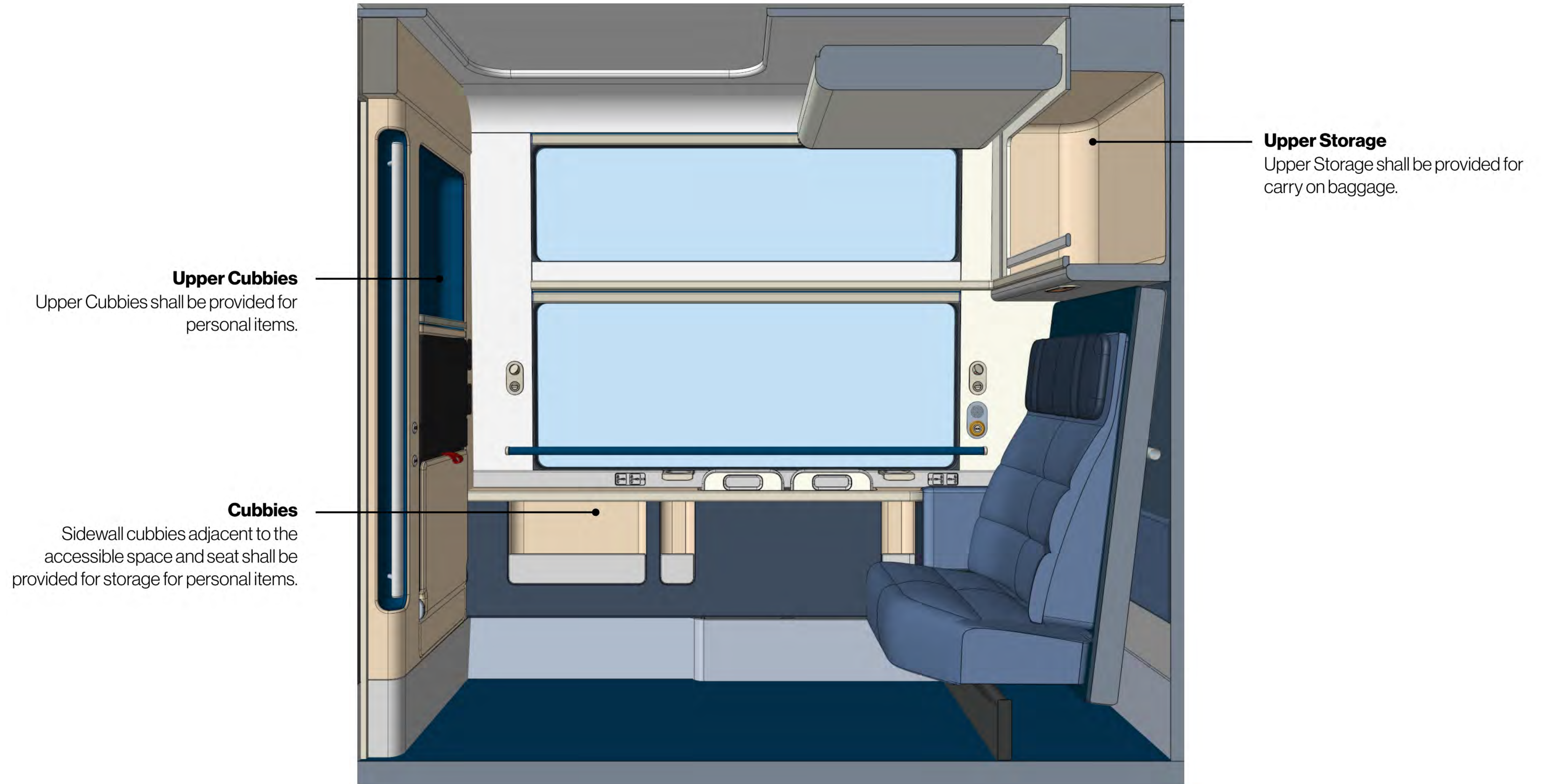

Accessible Bedroom | Storage

Bunk Cubby

Bunk cubbies provide storage for personal items. Usable when bunk is stored and also provides storage for upper bunk when bunk is deployed.



Hanging Space

At least two coat hooks should be provided on the inner wall, suitable to hang clothes or provide the function of an open wardrobe. The lower hook should be accessible for a person using a wheelchair at a maximum of 48" from the finish floor.

Lower Storage

Storage for carry on baggage shall be provide at an accessible lower level beside or under the seating area.

Accessible Bedroom | Seat to Bed Conversions

Accessible Bedroom | Seat to Bed Conversions

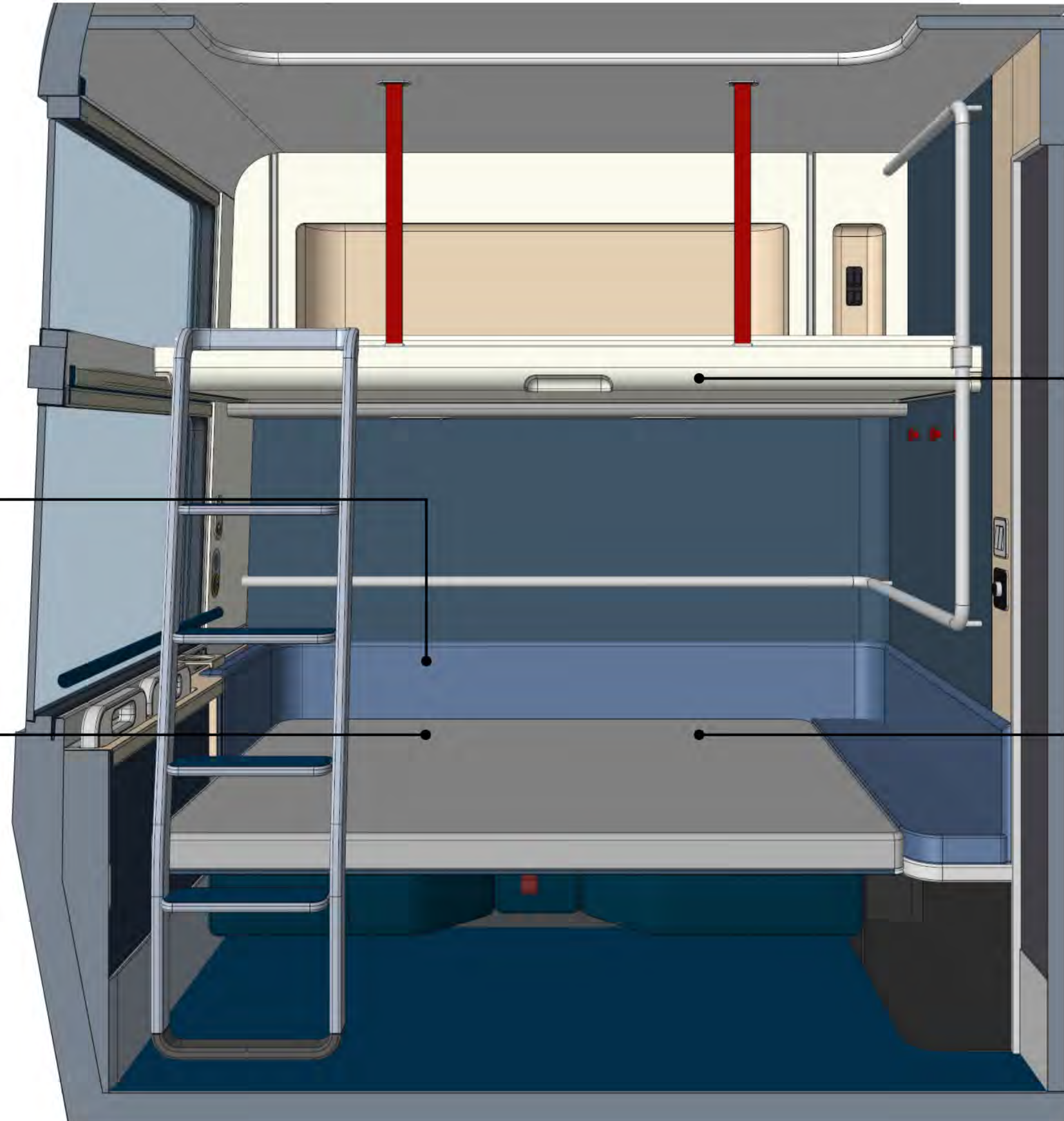

Bed Headboard

The armrest and ottoman side pad should continue and connect to form a thin soft wrap around the bed.

Lower Berth

Conversion of seat to bed should result in an entirely flat bed surface. The mattress surface should be integral to the seat. A single seam between the bed surface and the Ottoman is acceptable. A single thin topper will finish the bed surface.

Bunk Dimensions

Minimum width 28" x Minimum length 76".

Lower Berth Dimensions

Minimum width 48" x minimum length 73" when combined with the Ottoman.

Accessible Bedroom | Seat to Bed Conversions

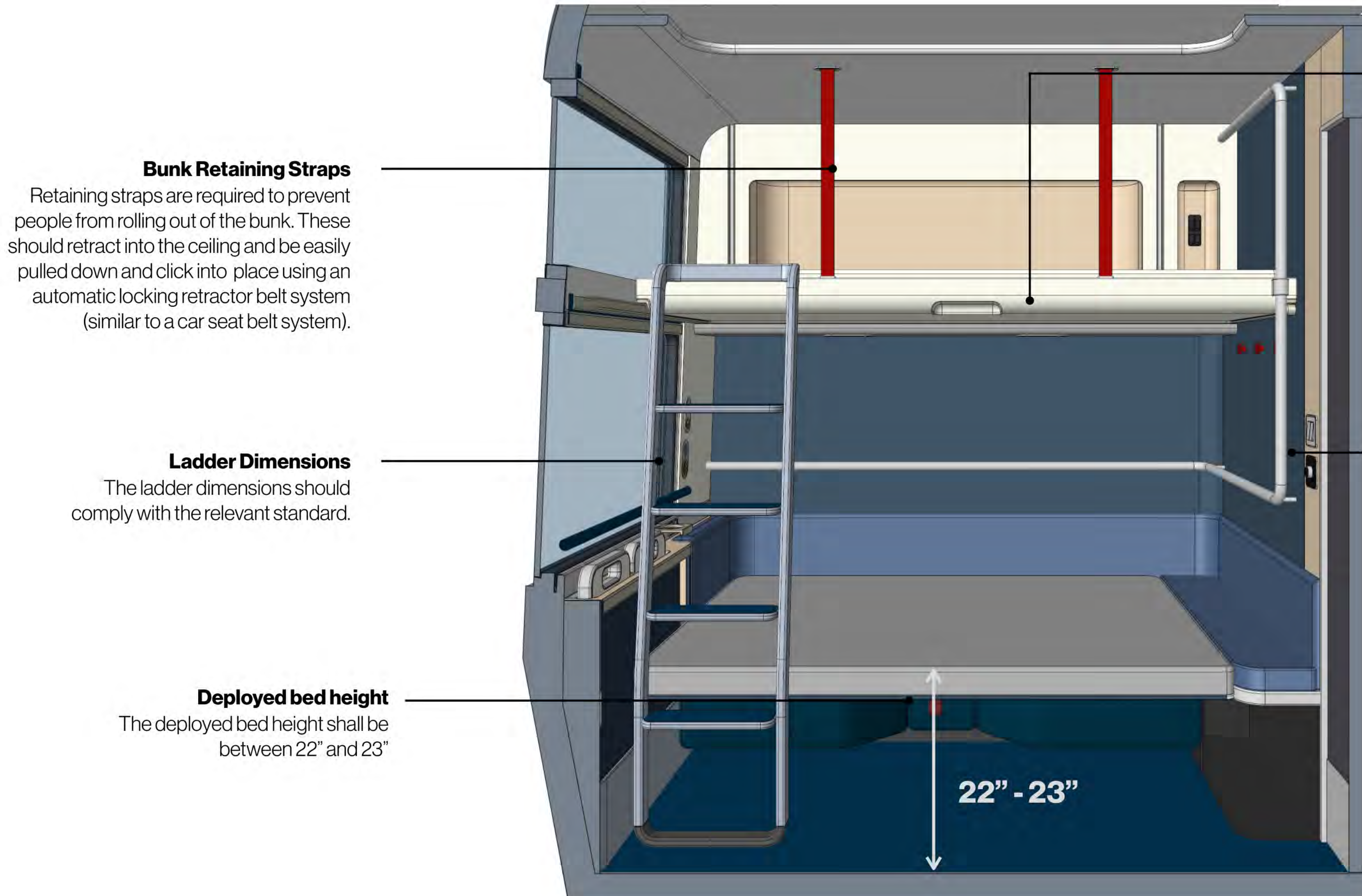

Bunk Retaining Straps

Retaining straps are required to prevent people from rolling out of the bunk. These should retract into the ceiling and be easily pulled down and click into place using an automatic locking retractor belt system (similar to a car seat belt system).

Ladder Dimensions

The ladder dimensions should comply with the relevant standard.

Deployed bed height

The deployed bed height shall be between 22" and 23"

Bunk Height

The bunk height when deployed will be evaluated and judged carefully during the design review process.

The seated area below the bunk should still be usable by seated passengers when the upper bunk is deployed. The area should still be well lit and tables and other amenities should not be restricted by a deployed bunk bed.

Handrails and Grabs

Suitable handholds shall be provided to assist people transitioning on both sides to the bunk. Additional handholds may be required to assist people climbing down safely from the bunk.

Accessible Bedroom | Seat to Bed Conversions

Ladder

The ladder is stored in the bunk. It should be durable and lightweight. It should not have any sharp corners or edges. It must be intuitive to use and locate. The fixation method should be robust and easy to lock and unlock. Successful locking should be visually indicated and safety measures should be put in place to prevent accidental unlatching and prevent misuse. The ladder should be usable in multiple positions based on user specific needs and preference. Each step should clearly contrast the floor and it should also have integrated battery powered lights for safe use during low level light conditions.

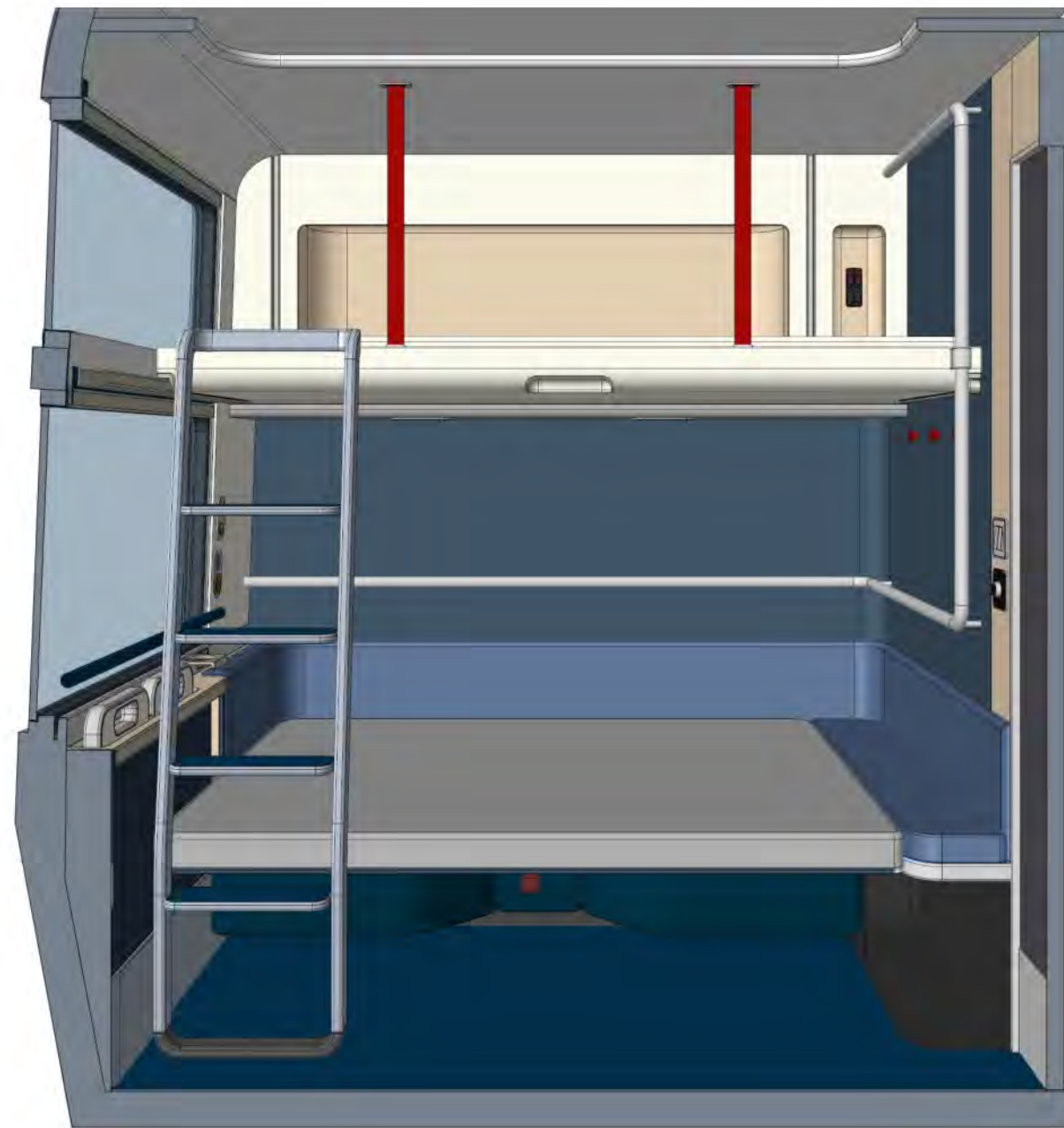

Ladder position 1

Maintains a 60" turning circle on the floor.

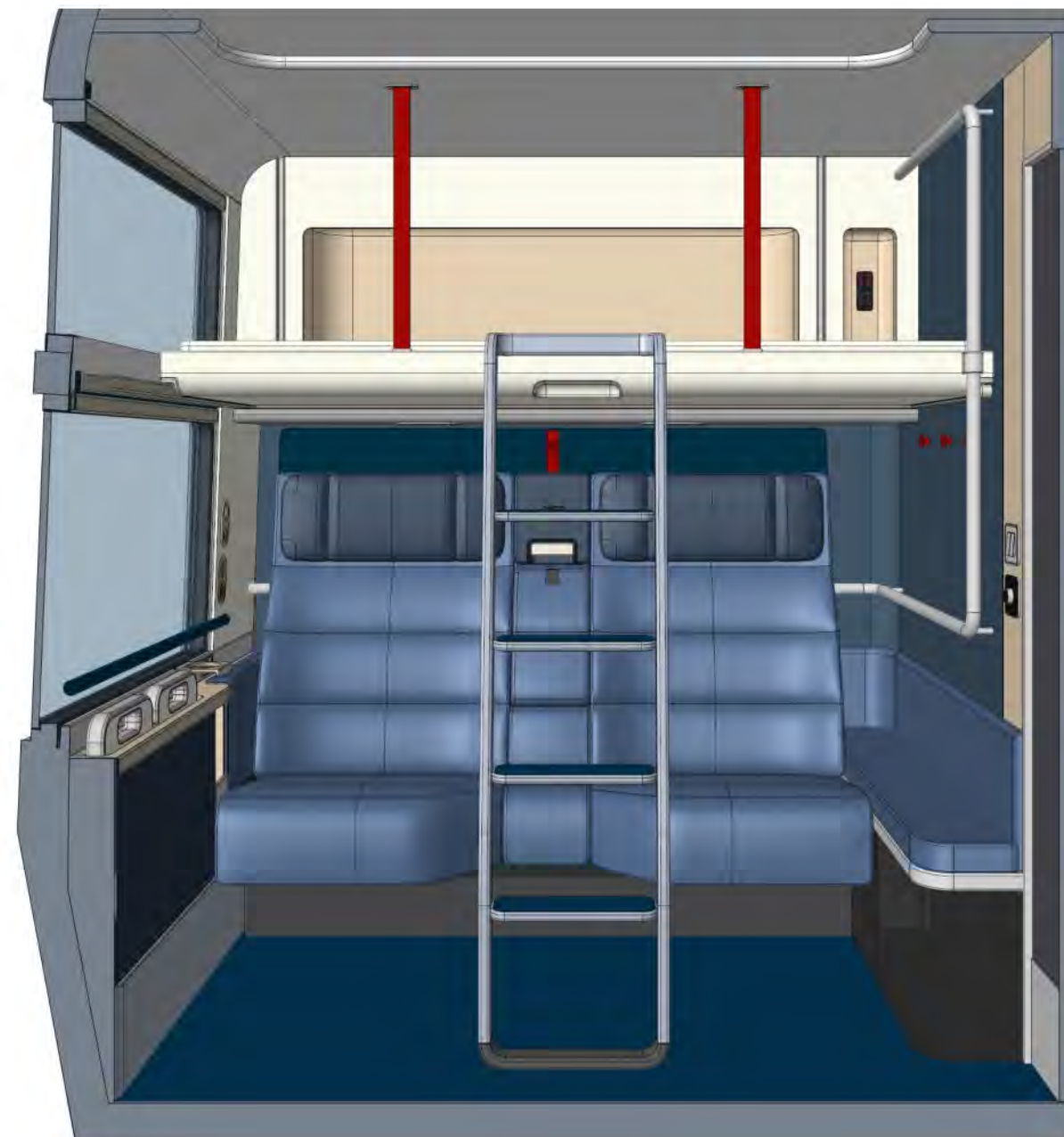

Ladder position 2

Bunk down and a passenger in both seats.

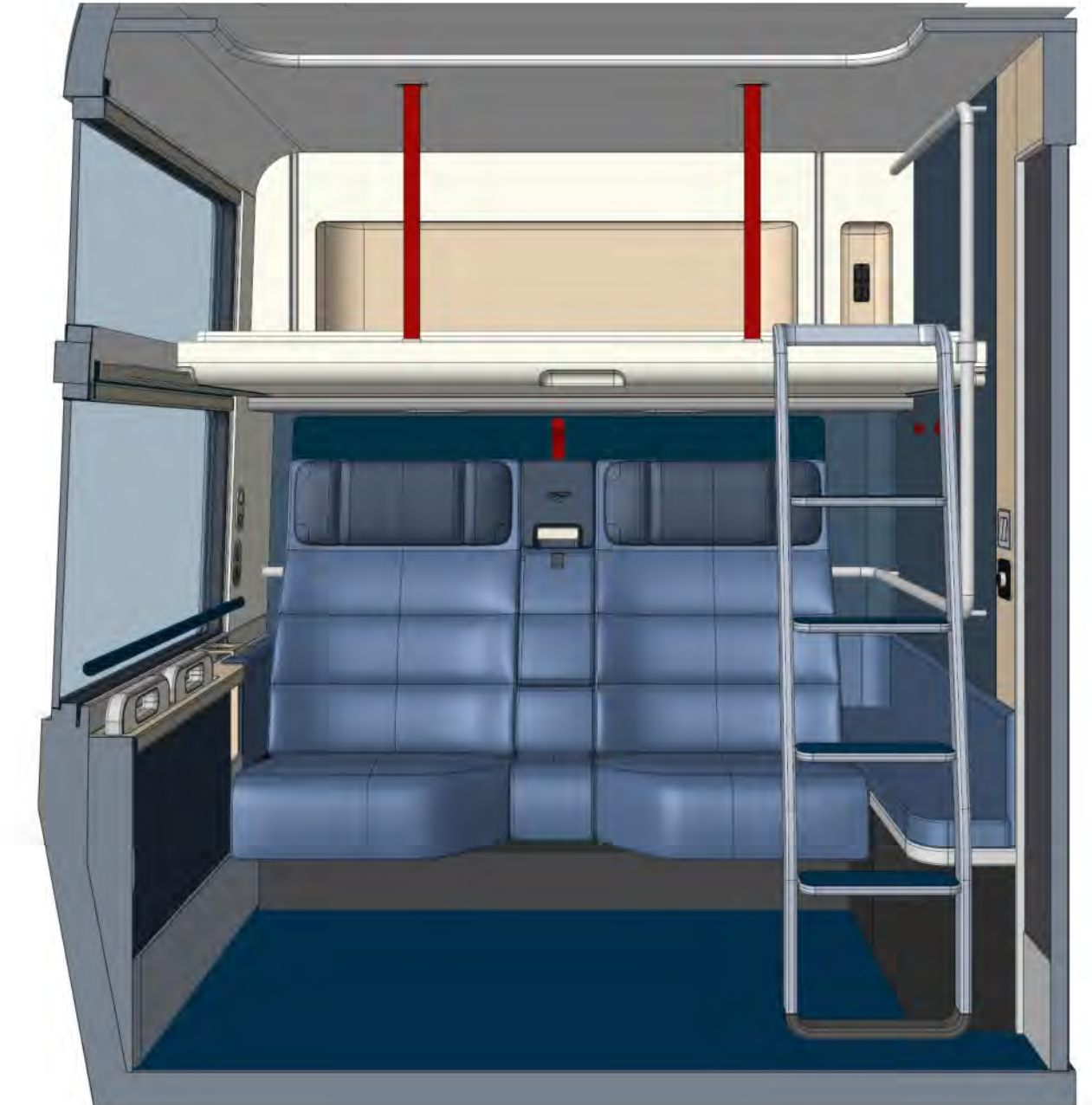

Ladder position 3

Accessible space clear and one seat occupied.

Accessible Bedroom | Seat to Bed Conversions

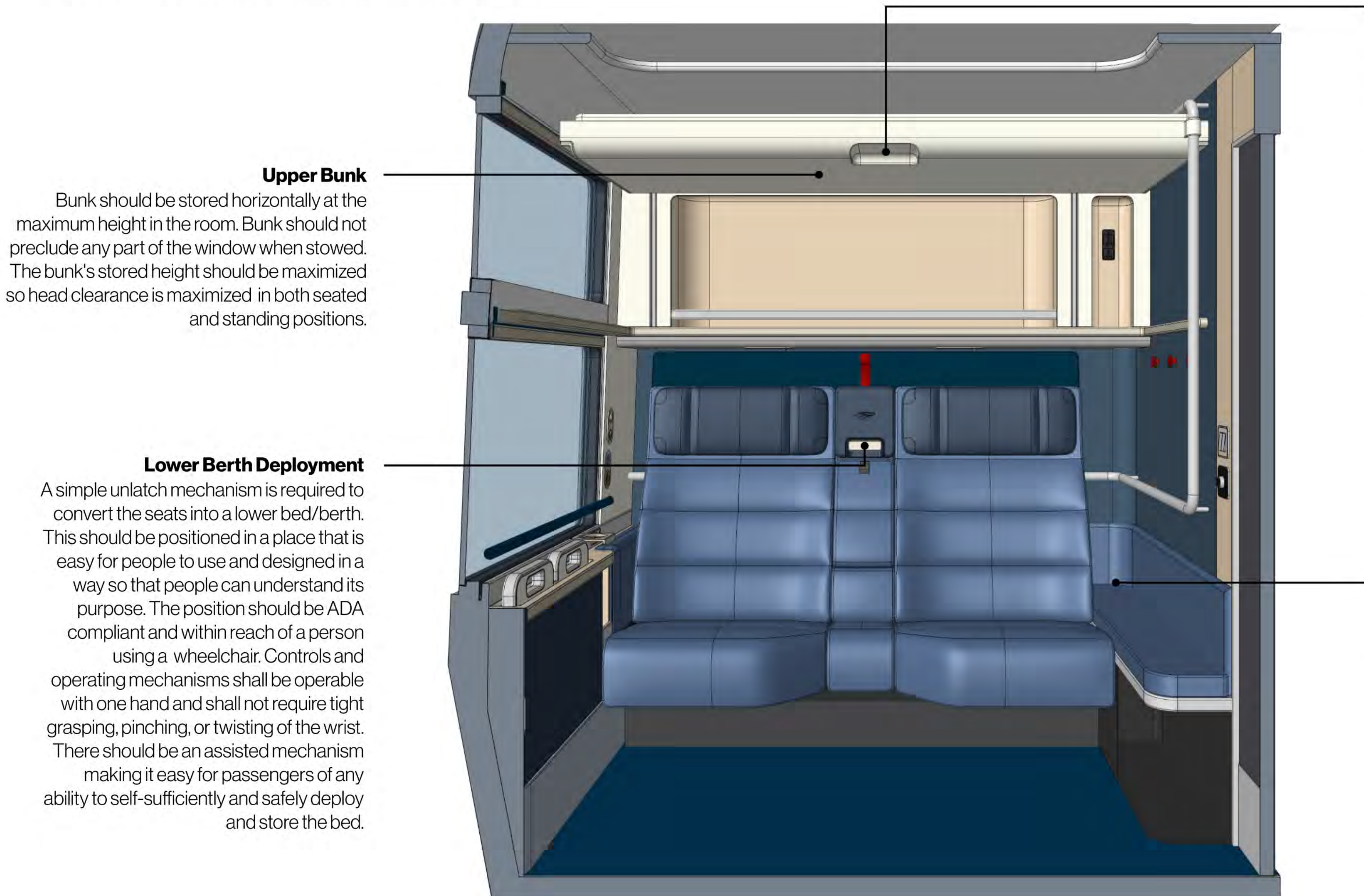

Upper Bunk

Bunk should be stored horizontally at the maximum height in the room. Bunk should not preclude any part of the window when stowed. The bunk's stored height should be maximized so head clearance is maximized in both seated and standing positions.

Upper Bunk Deployment

A simple and easy to use handle, latch and lock mechanism should be within easy reach from a standing position. Successful locking should be visually indicated and safety measures should be put in place to prevent accidental deployment and prevent misuse.

The bunk deployment should be free from jamming and racking and should lower slowly and in a controlled manner. Considerations should be made for assisted movement or counter balances to assist people moving the bunk down and back up into the stowed position.

Lower Berth Deployment

A simple unlatch mechanism is required to convert the seats into a lower bed/berth. This should be positioned in a place that is easy for people to use and designed in a way so that people can understand its purpose. The position should be ADA compliant and within reach of a person using a wheelchair. Controls and operating mechanisms shall be operable with one hand and shall not require tight grasping, pinching, or twisting of the wrist. There should be an assisted mechanism making it easy for passengers of any ability to self-sufficiently and safely deploy and store the bed.

Ottoman

An ottoman can be provided by the side of the seats to form part of the bed surface. The top surface can be used as additional storage during the day. Carry on stowage can be stored under the ottoman.

Accessible Bedroom | Seat to Bed Conversions

Bed Dimensions

All bed dimensions, mattress densities will be subject to mockup review and approval by Amtrak.

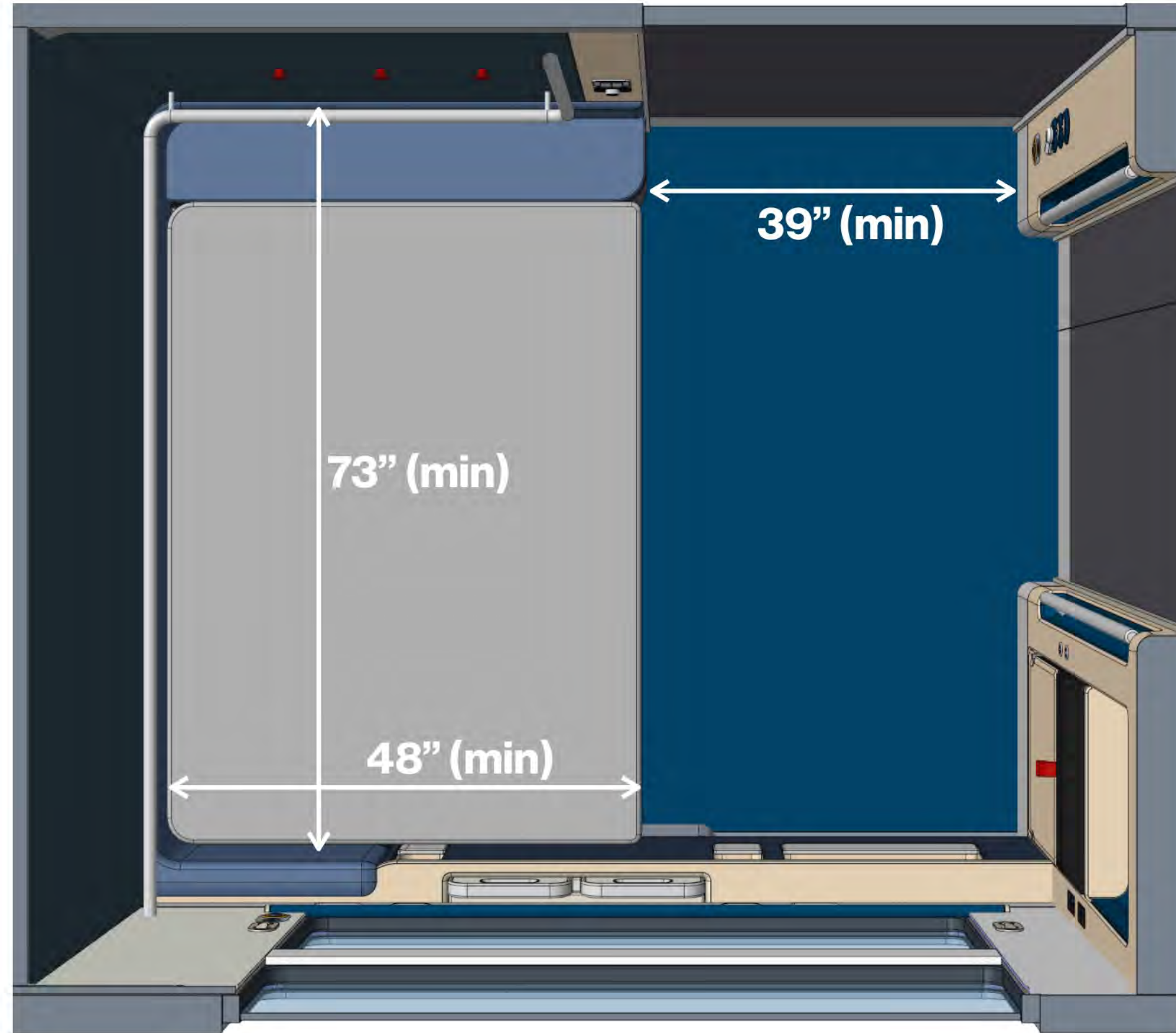

Accessible Bedroom | Seat to Bed Conversions

Bed Dimensions

All bed dimensions, mattress densities will be subject to mockup review and approval by Amtrak.

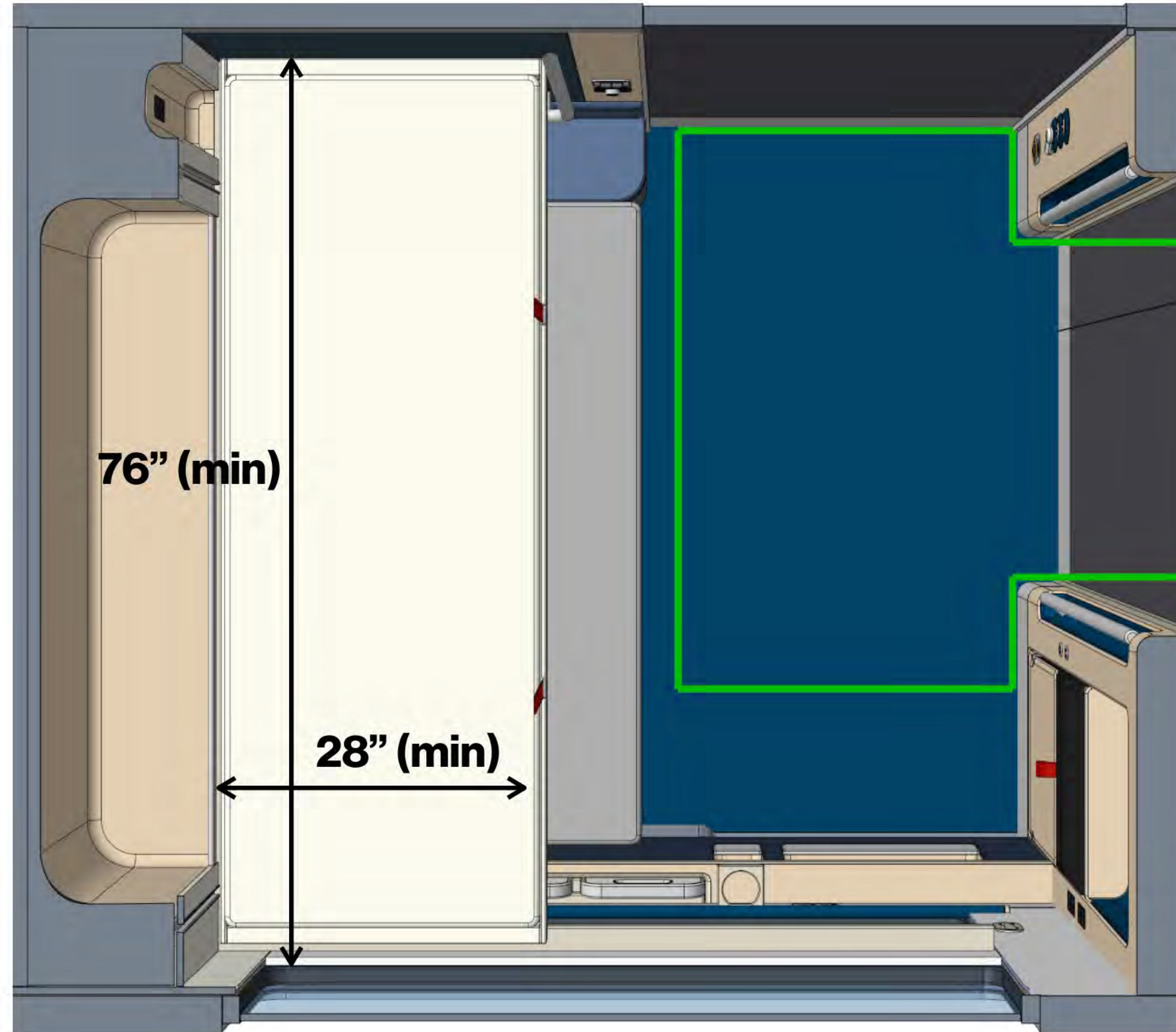

Accessible Bedroom | Lighting

Accessible Bedroom | Lighting



Wall Wash Light
Indirect wash light running down both sides of room.



Ceiling Pool Light
Ring pool lighting in the ceiling provides indirect wash light in the centre of the room.

*See lighting spec for detailed definition.

Accessible Bedroom | Lighting



Under Seat Light

Under seat light should be indirect and spill light out across the floor.



Reading Lights

Reading lights should be provided at each seated location, including the fold out seat. People should be able to adjust the direction and position the light over their lap and in a suitable place to read a book at night. Switches should be located near or on the light.

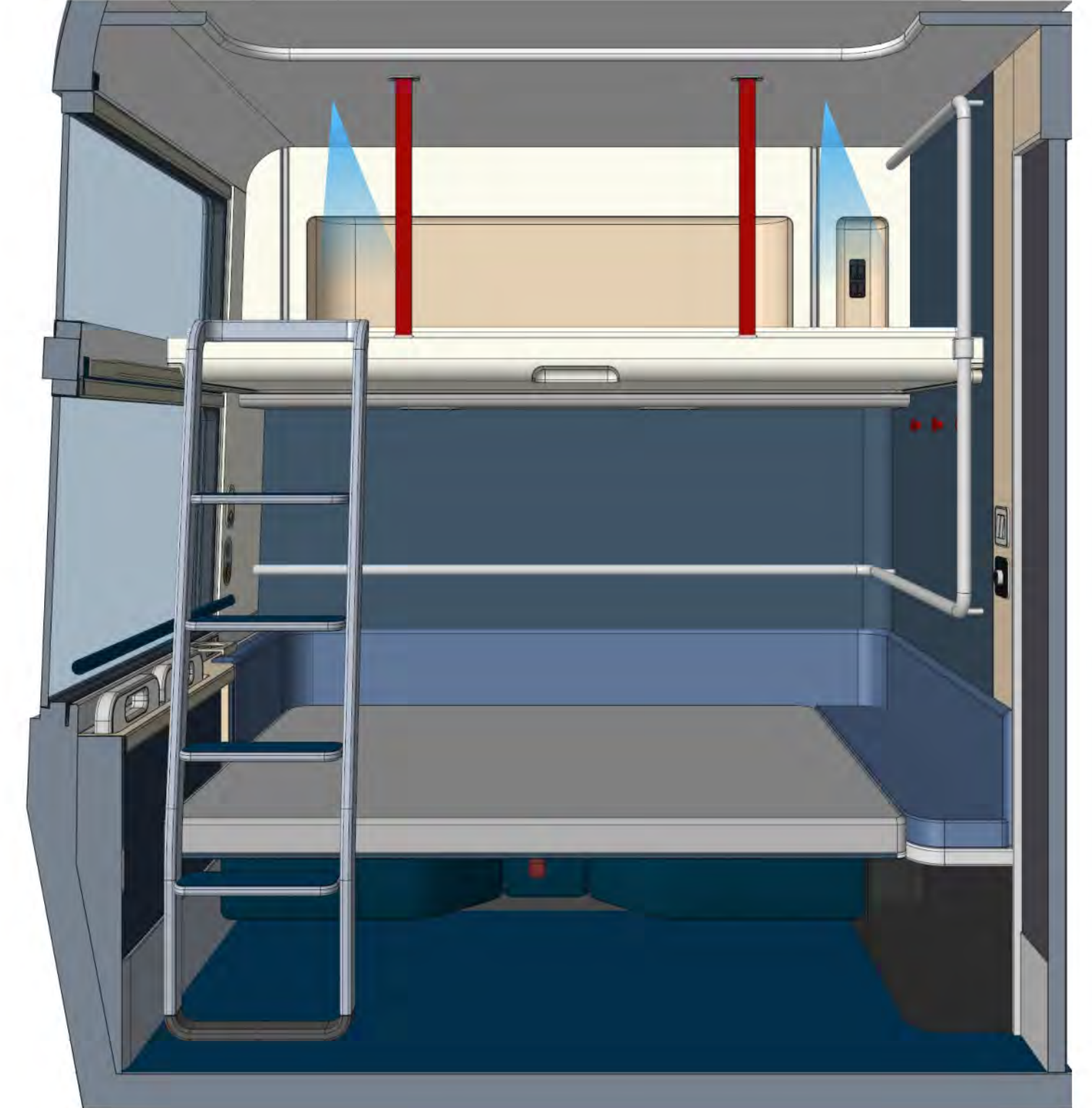

Bunk Reading Light

Reading lights should be provided, embedded in the ceiling above the bunk. Two lights in total located at each end of the bed. Light switches should be located next to the reading light.

*See lighting spec for detailed definition.

Accessible Bedroom Toilet | Accessibility

Accessible Bedroom Toilet | Accessibility

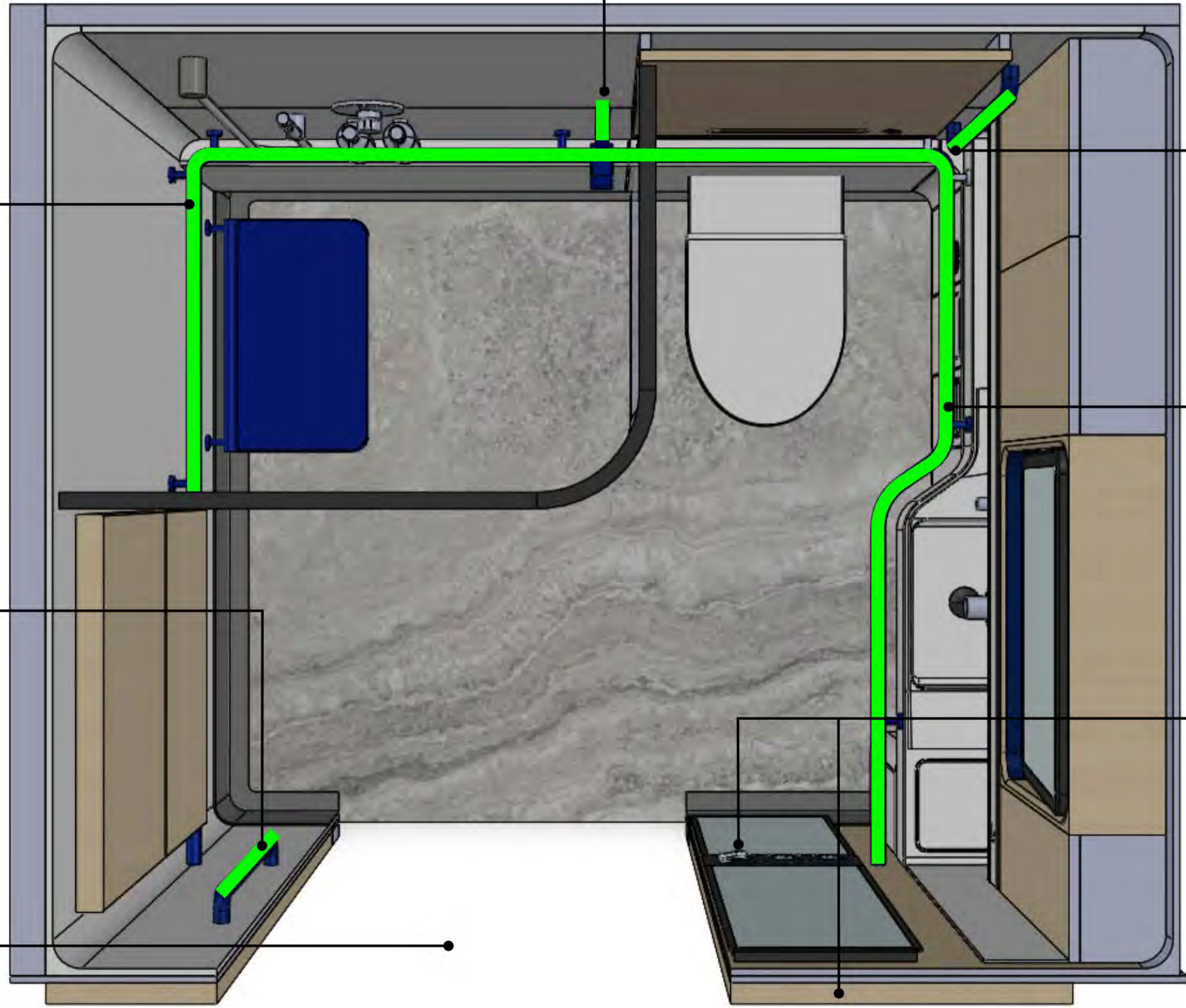

Shower Handrail

ADA compliant horizontal handrails positioned in the shower area. The handrail should be a compliant height and length.

Vertical Handrail 1

ADA compliant vertical handrails positioned adjacent to the bathroom door. It can also be used by baby changing table.

36" Toilet Door

The toilet door should be an automatic sliding door, this can be achieved with two leaves. The door is positioned to create space for a T maneuver when the door is open and the bed is deployed.

Fold Down Handrail

The fold down handrail can be used to aid transfer on to the shower seat and on to the toilet. When stored in the vertical position it should not protrude from the sidewall more than 3" to keep side transfer space clear for the toilet.

Vertical Handrail 2

ADA compliant vertical handrails positioned in front of the toilet.

Toilet + Sink Handrail

ADA compliant horizontal handrails positioned in the toilet and sink area. The handrail should be a compliant height and length. The handrails should be one continuous loop where possible.

Toilet Door Controls

The controls for the bathroom door must be ADA compliant in position, size and configuration. The buttons should be easy and intuitive to use. An accessible manual lock should be included with an indicator to show lock condition. The buttons should have visual and haptic feedback.

Accessible Bedroom Toilet | Accessibility

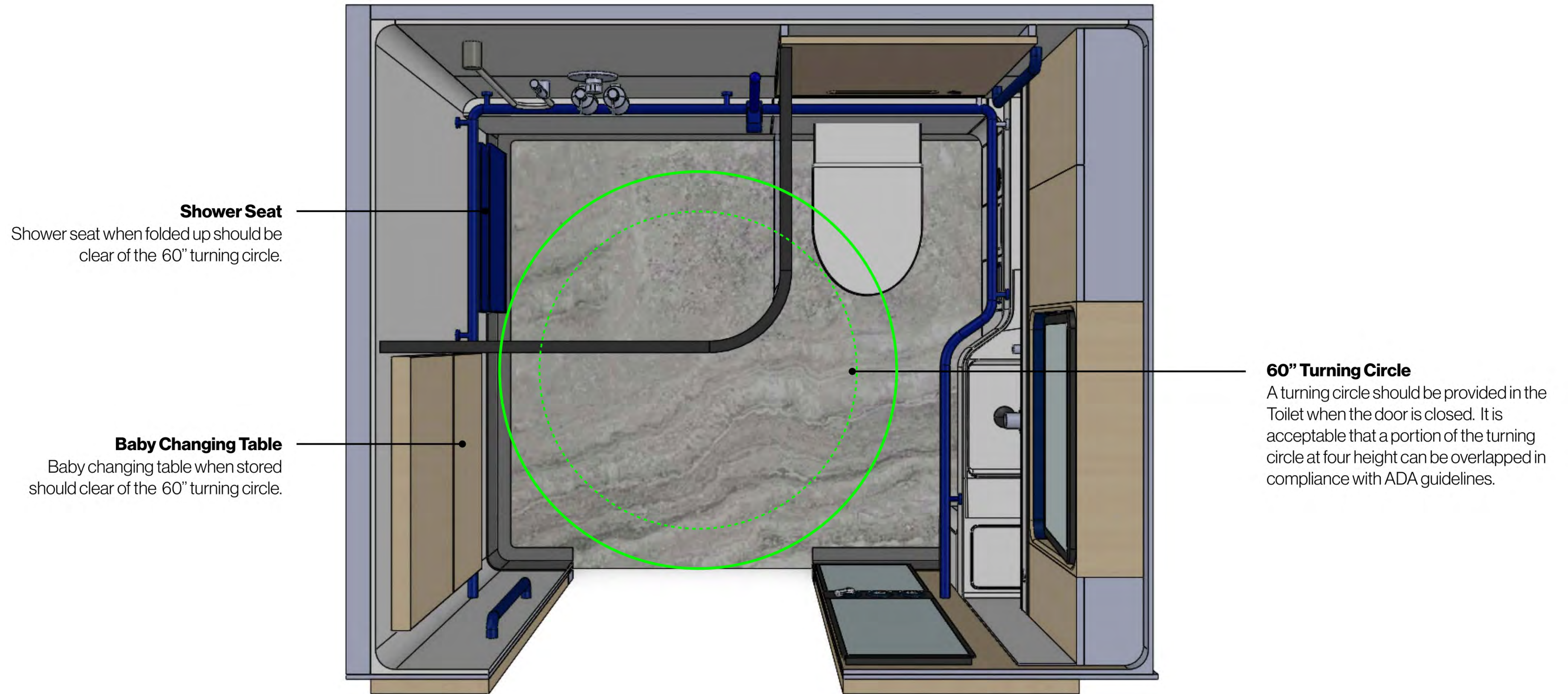

Accessible Bedroom Toilet | Accessibility

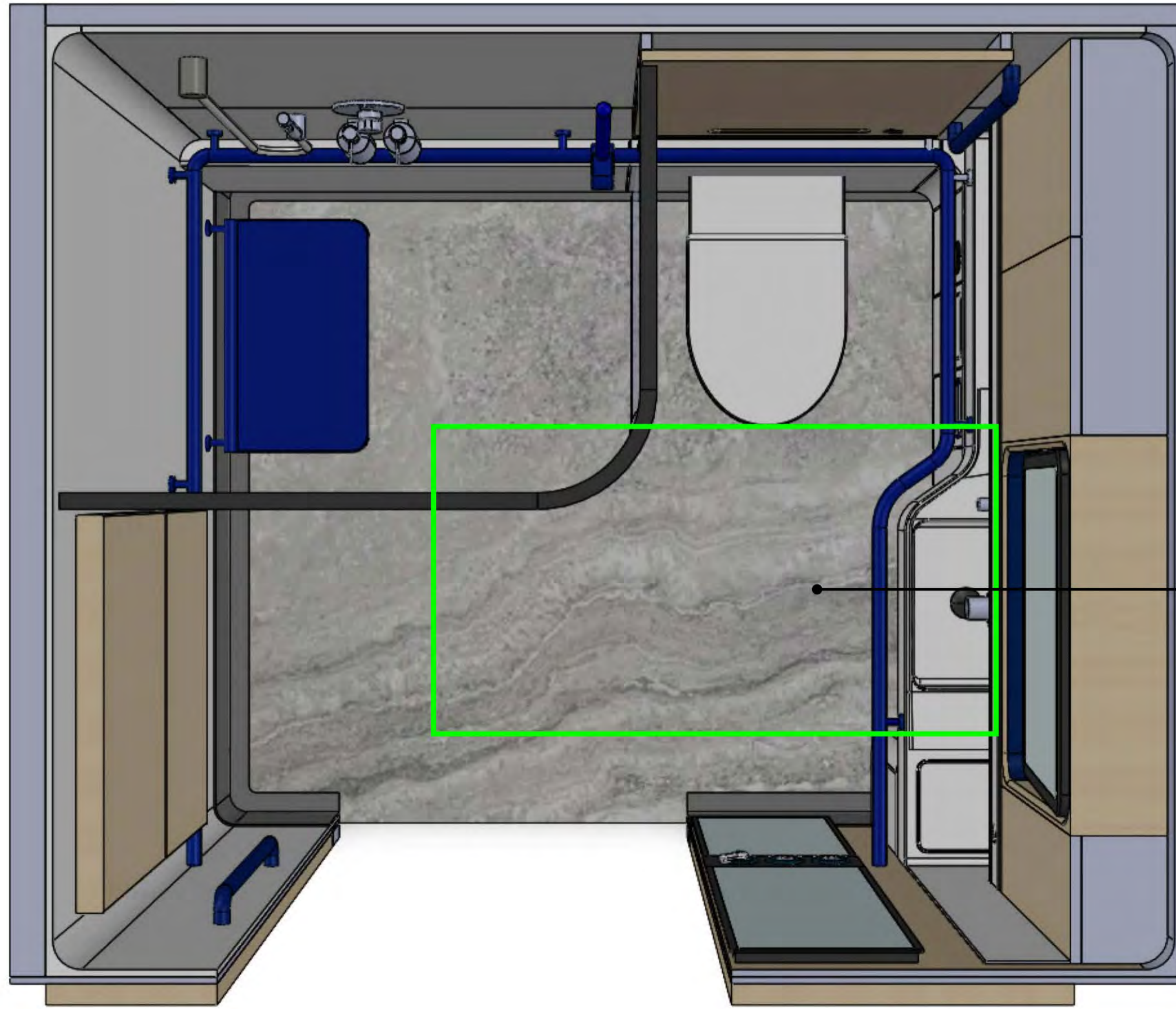

RVAAC Accessible Space 1
There should be clearance directly in front of the sink and vanity unit for an RVAAC accessible space of 59" x 32". The sink overhang should comply with ADA and RVAAC guidance. Dimensions and usability will be subject to mock-up testing and Amtrak approval.

Accessible Bedroom Toilet | Accessibility

RVAAC Accessible Space 2
There should be clearance between the toilet and shower seat when folded down for an RVAAC accessible space of 59" x 32". This position should be suitable for side transfer to the toilet and the shower seat.

RVAAC Accessible Space 3
There should be clearance between the shower seat when folded down and the door sidewall for an RVAAC accessible space of 59" x 32". This position should be suitable for side transfer the shower seats and access for the baby changer.

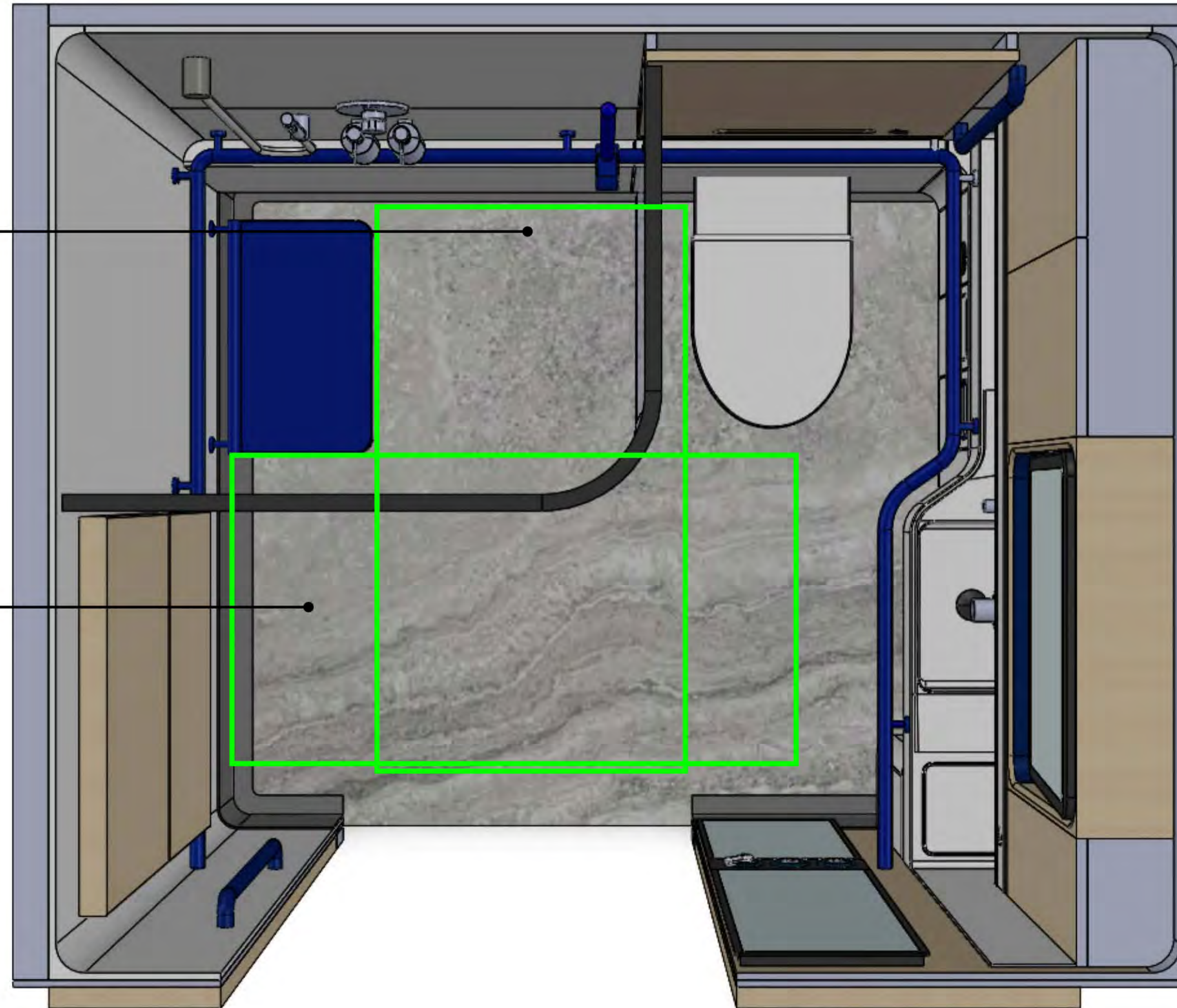

Accessible Bedroom Toilet | Accessibility

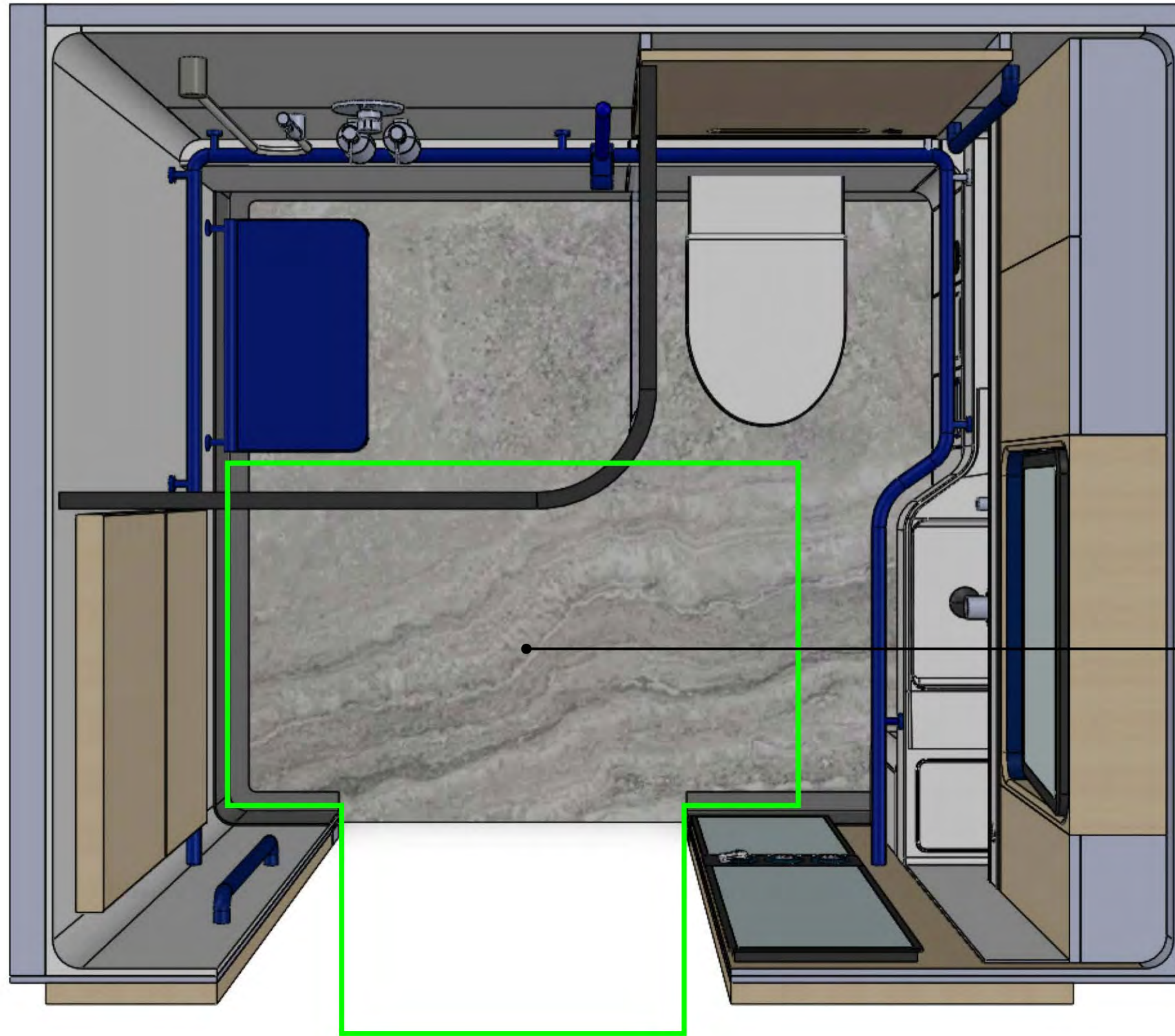

ADA T- manuever Space
When the shower seat is folded down, there should be clearance for a T- manuever through the bathroom door.

Accessible Bedroom Toilet | Room Features

Accessible Bedroom Toilet | Amenities and Features

Sanitary Waste
A sanitary bin with modesty flap is provided to the right of the toilet. Position and function should comply with ADA.

Toilet Seat Cover Dispenser
A dispenser for paper toilet seat covers should be located by the toilet. Position and function should comply with ADA regulations.

Call for Aid Button
There should be a call for aid button adjacent to the toilet. Position and function should comply with ADA.

Toilet Flush
A two button touch-less flush is located on the back wall providing standard and eco flush. Position and function should comply with ADA.

Toilet
The toilet has a seat and a cover. The form of the toilet is undercut at the bottom to maximize wheelchair clearance. Toilet seat and seat lid should all have soft close mechanisms.

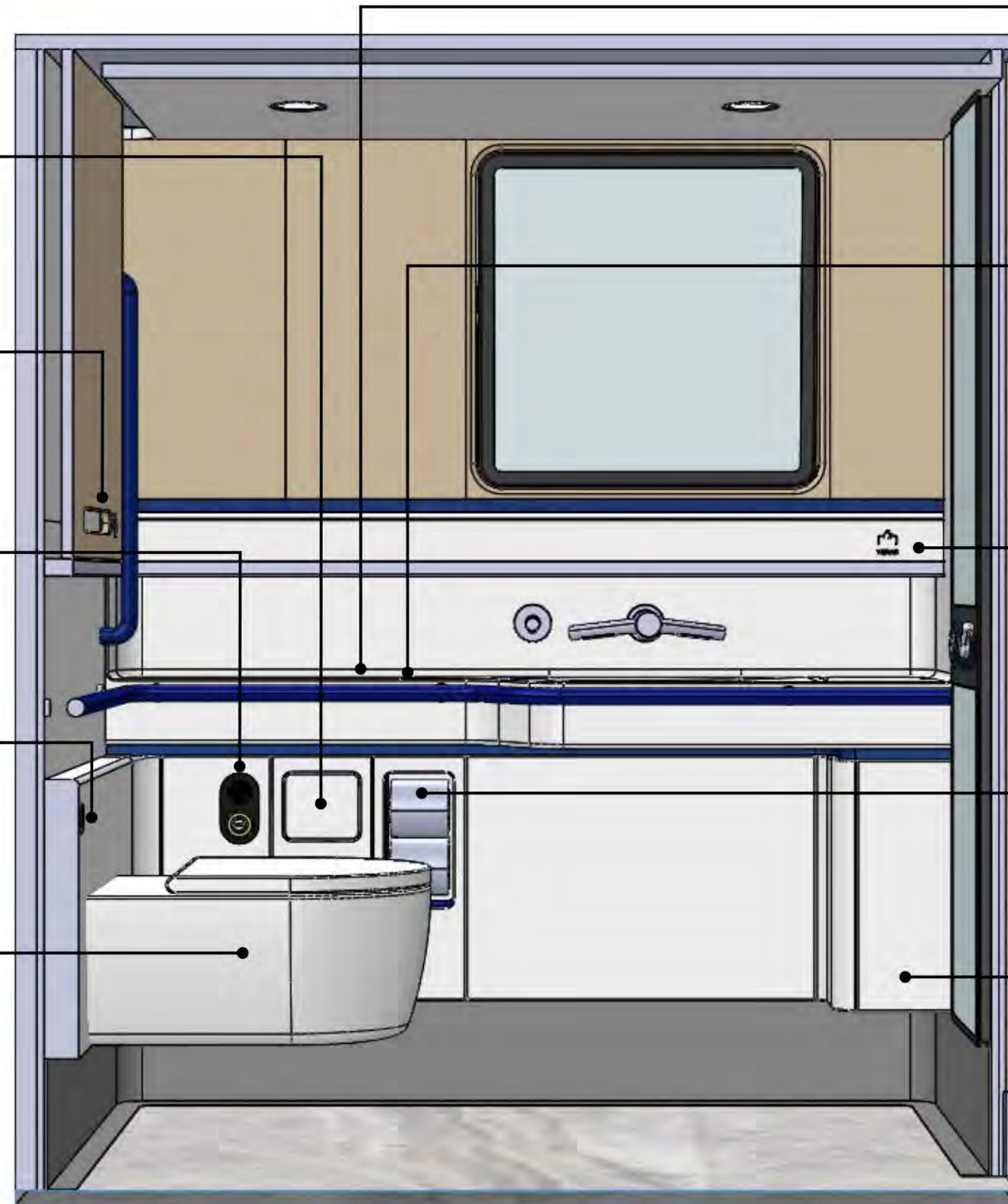

Sharps Bin
Provision for a sharps bin should be provided within the room.

Sink Surface
Sink surface should be large enough to store a wash bag and toiletry items and aid the safe and clean disposal of a colostomy bag. Marine edge should run along entire length and a draining surface angled towards sink.

Tissue Dispenser
Tissue dispenser should be positioned near the trash and sink.

Toilet Paper Storage
The toilet paper should be stored in the wall of the bathroom.

Trash
A trash bin is provided to the right of the sink. The volume should be 14 gallons minimum. Position and function should comply with ADA. The opening to the trash should be a minimum of 8" x 10".

Accessible Bedroom Toilet | Amenities and Features

Crew Cabinet

Cabinet storage is provided for crew to store cleaning and bathroom servicing items.

Automatic Water Faucet

Water is automatically dispensed when hands are placed under the faucet. A physical element should be visible so it is clear where water is dispensed from. Temperature of water should be controllable. Water pressure, water flow should not create any water splash or spill outside of the sink area.

Automatic Hand Drier

An automatically triggered hand dryer should be included under the vanity unit. This can be part of the faucet or supplied separately. A physical element should be visible so it is clear how to use the dryer. The dryer should use high velocity air and HEPA filters similar to a Dyson Airblade. The air dryer should not blow water out of the sink.

Soap Dispenser

An automatic soap dispenser should be included above the sink area. A physical element should be present to indicate how and where the soap will dispense.

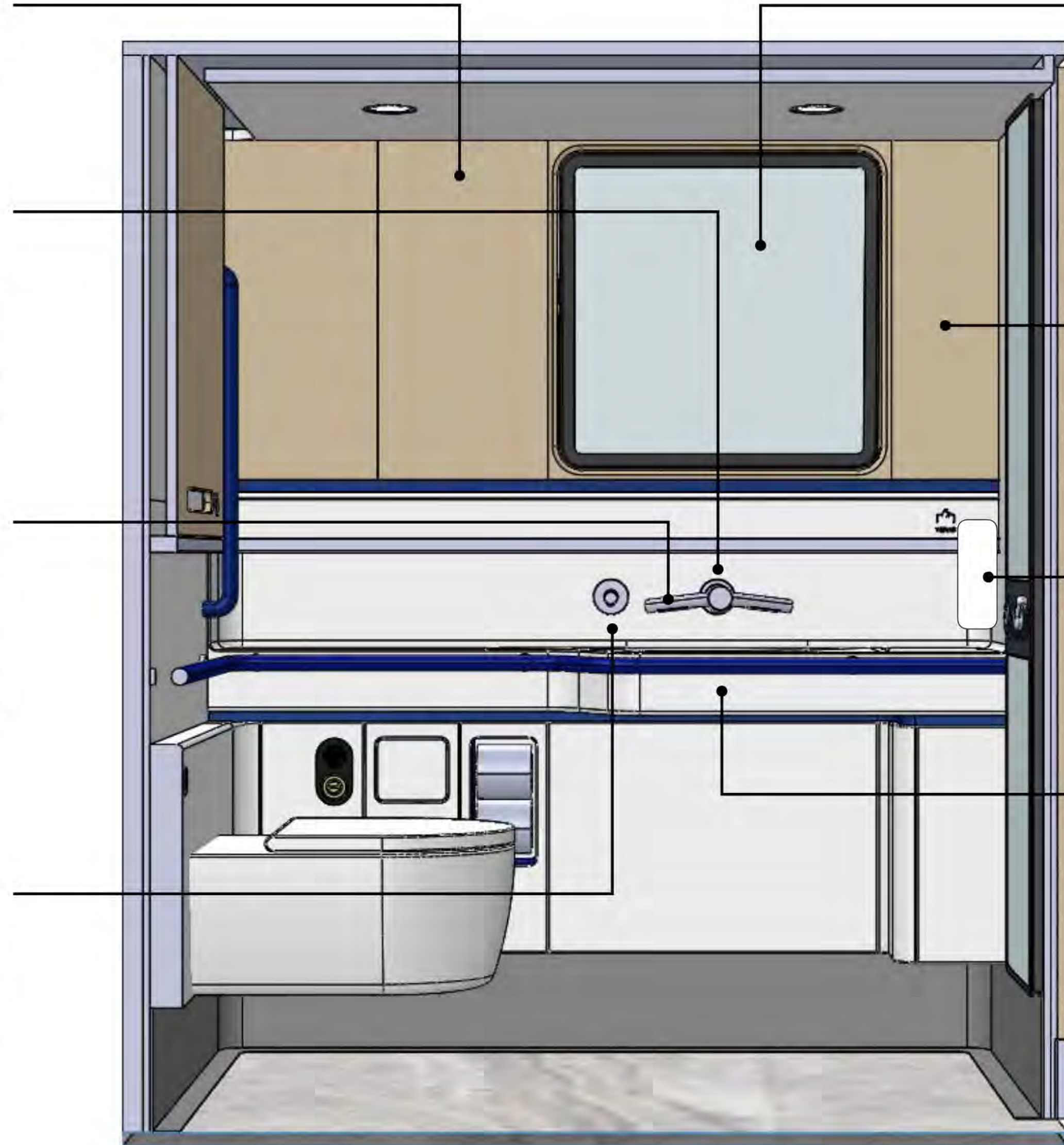

Vanity Mirror

A large mirror is positioned in front of the sink. The bottom edge of the reflective surface should be a maximum of 40" above the finish floor. If this is not possible, the mirror should be angled to allow wheelchair passengers to use it.

Passenger Cabinet

A cabinet to the right of the mirror should be provided for passengers to store personal toiletry items. The position of the lower portion of this cabinet should comply with ADA reach rules.

Hand Lotion Bottle

An area on the side of the sink should be reserved for a refillable hand lotion bottle fixed to the side wall.

Sink

The sink should have a marine edge so any water spill is captured in the sink area. A splash back behind the sink should protect the surrounding areas from water splashed onto the back wall from the sink area. The sink should be accessible while sat on the toilet.

Accessible Bedroom Toilet | Amenities and Features

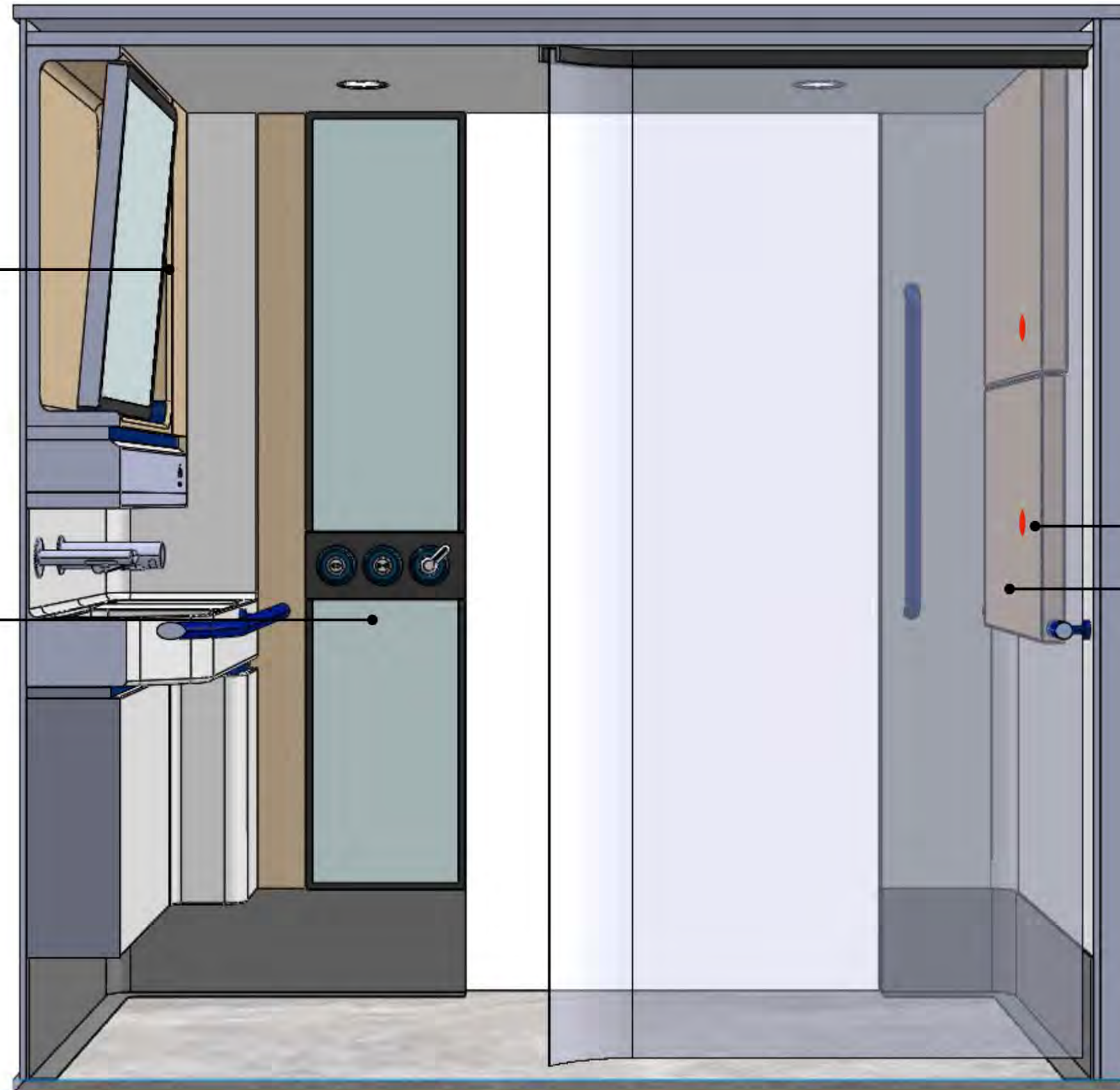

Towel Storage

A cabinet, surface or hooks should be provided to store bath towels, face cloths and hand towels (2 of each standard Amtrak towels). These should be located in a position accessible for a person using a wheelchair

Full Length Mirror

A full length mirror should be provided in addition to the sink mirror. The bottom edge of the reflective surface should be a maximum of 40" above the finish floor.

Towel Hooks

At least two towel hooks should be provided. One hook must be within the reach range of a person using a wheelchair at a maximum height of 45".

Fold Down Baby Changing

A baby changing table should be provided with an RVAAC compliant clear space in front of it. The changing table should be easy to deploy and stow with an intuitive handle. The mechanism should be durable, free from jamming and racking. The design should meet abuse loads. It should have a soft opening mechanism. Position and function should comply with ADA.

Accessible Bedroom Toilet | Amenities and Features

Drainage

The floor in the shower area should be designed to minimize water spreading to other parts of the room with a drainage angle directing water towards a covered drain in the corner of the room. The floor must also allow wheelchair passengers complete freedom to turn and maneuver in the room with floor levels compliant with ADA regulations.



Accessible Bedroom Toilet | Amenities and Features

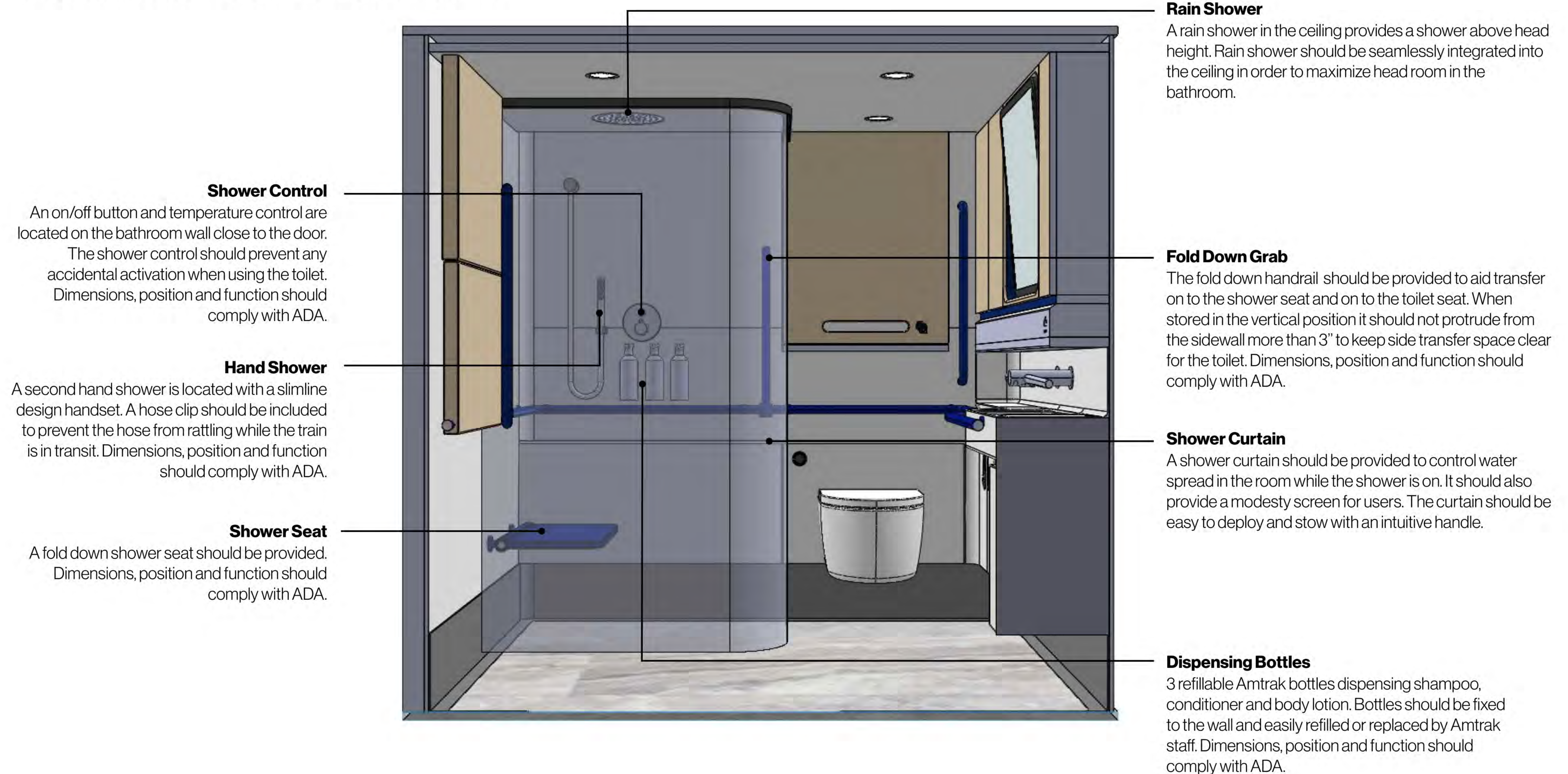

Accessible Bedroom Toilet | Lighting

Accessible Bedroom Toilet | Lighting

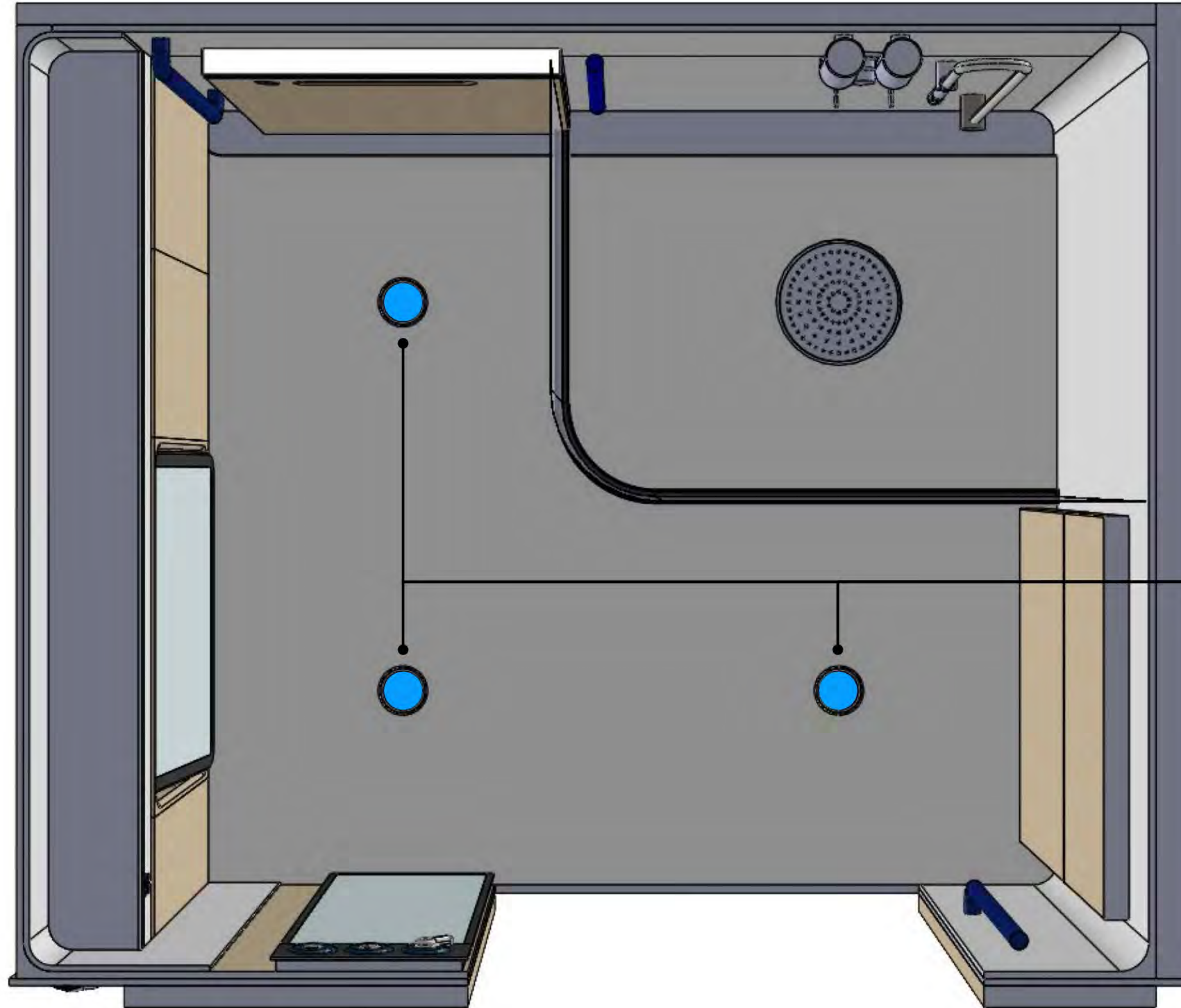

LED light panel spot

Small circular LED light panels act as spot lights - frame to be color matched. Activated only when door is locked from the inside. Position, number and style to be approved by Amtrak.

Accessible Bedroom Toilet | Lighting



LED Illuminated Mirror

The vanity mirror is illuminated with an LED strip around the border. Activated with a switch located near or on the mirror.

Vanity Wash Light

The cabinet washes indirect light on to the sink surface. Activated only when door is locked from the inside.

Floor Wash Light

Lower sidewall panels wash indirect light on to the floor. Activated by the master control switch.